



WD-52628

WD-62628

WD-73727

Projection Television Owner's Guide

TV Information

Use this space to record the model number and serial number of your television. This information is on the back of your TV.

Model Number _____

Serial Number _____

Purchase Date _____

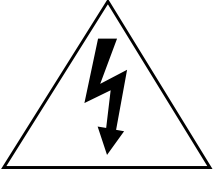

visit our website at
www.mitsubishi-tv.com

	<h1 style="margin: 0;">CAUTION</h1> <p style="margin: 0;">RISK OF ELECTRIC SHOCK DO NOT OPEN</p>	
CAUTION: TO REDUCE THE RISK OF ELECTRIC SHOCK, DO NOT REMOVE COVER (OR BACK). NO USER SERVICEABLE PARTS INSIDE. REFER SERVICING TO QUALIFIED SERVICE PERSONNEL.		

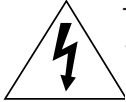

The lightning flash with arrowhead symbol within an equilateral triangle is intended to alert the user of the presence of uninsulated “dangerous voltage” within the product’s enclosure that may be sufficient magnitude to constitute a risk of electric shock.



The exclamation point within an equilateral triangle is intended to alert the user to the presence of important operating and maintenance (servicing) instructions in the literature accompanying the appliance.

This TV is heavy! Exercise extreme care when lifting or moving. Lifting or moving the TV requires a minimum of two adults. To prevent damage to your TV, your TV should not be jarred or moved while it is turned on. Power off your TV before moving it.

Portions of the advanced circuitry of this TV must continue to operate even when the TV is turned off. Some of these circuits therefore need to be cooled at all times. A low power standby fan may be heard in a quiet environment. This is normal operation.

Custom cabinet installation must allow for proper air circulation around the television.

TV Guide On Screen® Access Requirements

TV Guide On Screen listings are not provided by Mitsubishi Digital Electronics America, Inc. Operation of TV Guide On Screen requires over-the-air or cable access to stations carrying TV Guide On Screen program listings. If listings are not available in your area or become discontinued by the local provider, TV Guide On Screen will not operate. TV Guide On Screen does not provide program listings for satellite TV systems.

Stand Requirement

CAUTION: Use these Mitsubishi TV models only with the Mitsubishi stand models shown here. Use with other stands can result in instability and possibly cause injury.

TV Model Number	Stand Model Number
WD-52628	MB-52528
WD-62628	MB-62528
WD-73727	MB-73727

Lamp Replacement

The image on this TV is produced by a powerful lamp that will operate for many hours. Eventually, however, this lamp will need to be replaced. It is designed to be easily replaced by the TV owner. Front panel indicators and/or on-screen messages will assist you in determining when the lamp needs to be replaced. Please see Appendix H for details on lamp replacement. To order a new lamp:

While Under Warranty	After Warranty	
Call (800) 332-2119. Please have model number, serial number, and TV purchase date available.	Call (800) 553-7278. Order a new lamp for your TV model as shown below.	
	TV Model Number	Lamp Part Number
	WD-52628, WD-62628	915P026010
	WD-73727	915P027010

WARNING: TO REDUCE THE RISK OF FIRE OR ELECTRIC SHOCK, DO NOT EXPOSE THIS APPLIANCE TO RAIN OR MOISTURE.

CAUTION: TO PREVENT ELECTRIC SHOCK, MATCH WIDE BLADE OF PLUG TO WIDE SLOT, FULLY INSERT.

NOTE TO CATV SYSTEM INSTALLER: THIS REMINDER IS PROVIDED TO CALL THE CATV SYSTEM INSTALLER’S ATTENTION TO ARTICLE 820-40 OF THE NEC THAT PROVIDES GUIDELINES FOR THE PROPER GROUNDING AND, IN PARTICULAR, SPECIFIES THAT THE CABLE GROUND SHALL BE CONNECTED TO THE GROUNDING SYSTEM OF THE BUILDING, AS CLOSE TO THE POINT OF CABLE ENTRY AS PRACTICAL.

FCC Declaration of Conformity

Product: Projection Television Receiver

Models: WD-52628, WD-62628, WD-73727

Responsible Party: Mitsubishi Digital Electronics America, Inc.
9351 Jeronimo Road
Irvine, CA 92618-1904

Telephone: 949-465-6000

This device complies with Part 15 of the FCC Rules. Operation is subject to the following two conditions:

- (1) This device may not cause harmful interference, and
- (2) this device must accept any interference received, including interference that may cause undesired operation.

Note: This equipment has been tested and found to comply with the limits for a Class B digital device, pursuant to part 15 of the FCC Rules. These limits are designed to provide reasonable protection against harmful interference in a residential installation. This equipment generates, uses and can radiate radio frequency energy and, if not installed and used in accordance with the instructions, may cause harmful interference to radio communications. However, there is no guarantee that interference will not occur in a particular installation. If this equipment does cause harmful interference to radio or television reception, which can be determined by turning the equipment off and on, the user is encouraged to try to correct the interference by one or more of the following measures:

- Reorient or relocate the receiving antenna.
- Increase the separation between the equipment and the receiver.
- Connect the equipment into an outlet on a circuit different from that to which the receiver is connected.
- Consult the dealer or an experienced radio/TV technician for help.



CAUTION: To ensure continued FCC compliance, the user must use a shielded video interface or HDMI cable with bonded ferrite cores at both ends when using the PC input.

Changes or modifications not expressly approved by Mitsubishi could cause harmful interference and would void the user's authority to operate this equipment.

IMPORTANT SAFEGUARDS

Please read the following safeguards for your TV and retain for future reference. Always follow all warnings and instructions marked on the television.

1. Read, Retain and Follow All Instructions

Read all safety and operating instructions before operating the TV. Retain the safety and operating instructions for future reference. Follow all operating and use instructions.

2. Heed Warnings

Adhere to all warnings on the appliance and in the operating instructions.

3. Cleaning

Unplug the TV from the wall outlet before cleaning. Do not use liquid, abrasive or aerosol cleaners. Cleaners can permanently damage the cabinet and screen. Use a lightly dampened cloth for cleaning.

4. Attachments and Equipment

Never add any attachments and/or equipment without approval of the manufacturer as such additions may result in the risk of fire, electric shock or other personal injury.

5. Water and Moisture

Do not use the TV where contact with or immersion in water is possible. Do not use near bath tubs, wash bowls, kitchen sinks, laundry tubs, swimming pools, etc.

6. Accessories



Do not place the TV on an unstable cart, stand, tripod, or table. The TV may fall, causing serious injury to a child or adult and serious damage to the TV. Use only with a cart, stand, tripod, bracket or table recommended by the manufacturer, or sold with the TV. Any mounting of the TV should follow the manufacturer's instructions, and should use mounting accessories recommended by the manufacturer.

An appliance and cart combination should be moved with care. Quick stops, excessive force, and uneven surfaces may cause the appliance and cart combination to overturn.

7. Ventilation

Slots and openings in the cabinet are provided for ventilation and to ensure reliable operation of the TV and to protect it from overheating. Do not block these openings or allow them to be obstructed by placing the TV on a bed, sofa, rug, or other similar surface. Nor should it be placed over a radiator or heat register. If the TV is to be placed in a rack or bookcase, ensure that there is adequate ventilation and that the manufacturer's instructions have been adhered to.

8. Power Source

This TV should be operated only from the type of power source indicated on the marking label. If you are not sure of the type of power supplied to your home, consult your appliance dealer or local power company.

9. Grounding or Polarization

This TV is equipped with a polarized alternating current line plug having one blade wider than the other. This plug will fit into the power outlet only one way. If you are unable to insert the plug fully into the outlet, try reversing the plug. If the plug should still fail to fit, contact your electrician to replace your obsolete outlet. Do not defeat the safety purpose of the polarized plug.

10. Power-Cord Protection

Power-supply cords should be routed so that they are not likely to be walked on or pinched by items placed upon or against them, paying particular attention to cords at plugs, convenience receptacles, and the point where they exit from the TV.

11. Lightning

For added protection for this TV during a lightning storm, or when it is left unattended and unused for long period of time, unplug it from the wall outlet and disconnect the antenna or cable system. This will prevent damage to the TV due to lightning and power-line surges.

IMPORTANT SAFEGUARDS, continued

12. Power Lines

An outside antenna system should not be located in the vicinity of overhead power lines or other electric light or power circuits, or where it can fall into such power lines or circuits. When installing an outside antenna system, extreme care should be taken to keep from touching such power lines or circuits as contact with them might be fatal.

13. Overloading

Do not overload wall outlets and extension cords as this can result in a risk of fire or electric shock.

14. Object and Liquid Entry

Never push objects of any kind into this TV through openings as they may touch dangerous voltage points or short-out parts that could result in fire or electric shock. Never spill liquid of any kind on or into the TV.

15. Outdoor Antenna Grounding

If an outside antenna or cable system is connected to the TV, be sure the antenna or cable system is grounded so as to provide some protection against voltage surges and built-up static charges.

Article 810 of the National Electric Code, ANSI/NFPA No. 70-2002, provides information with respect to proper grounding of the mast and supporting structure, grounding of the lead in wire to an antenna discharge unit, size of grounding conductors, location of antenna discharge unit, connection to grounding electrodes, and requirements for the grounding electrode.

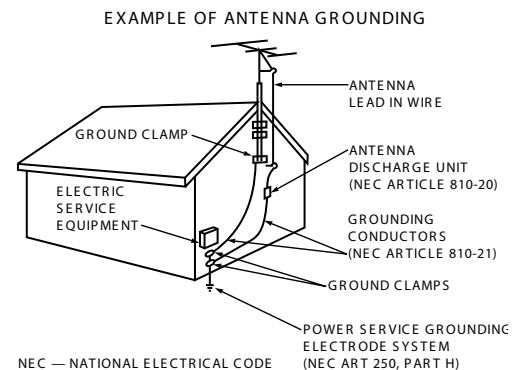

16. Servicing

Do not attempt to service this TV yourself as opening or removing covers may expose you to dangerous voltage or other hazards. Refer all servicing to qualified service personnel.

17. Damage Requiring Service

Unplug the TV from the wall outlet and refer servicing to qualified service personnel under the following conditions:

- When the power-supply cord or plug is damaged.
- If liquid has been spilled, or objects have fallen into the TV.
- If the TV has been exposed to rain or water.
- If the TV does not operate normally by following the operating instructions, adjust only those controls that are covered by the operating instructions as an improper adjustment of other controls may result in damage and will often require extensive work by a qualified technician to restore the TV to its normal operation.
- If the TV has been dropped or the cabinet has been damaged.
- When the TV exhibits a distinct change in performance - this indicates a need for service.

18. Replacement Parts

When replacement parts are required, be sure the service technician has used replacement parts specified by the manufacturer or have the same characteristics as the original part. Unauthorized substitutions may result in fire, electric shock or other hazards.

19. Safety Check

Upon completion of any service or repair to the TV, ask the service technician to perform safety checks to determine that the TV is in safe operating condition.

20. Heat

The product should be situated away from heat sources such as radiators, heat registers, stoves or other products (including amplifiers) that produce heat.

Contents

Chapter 1: Television Overview

TV Accessories	10
Special Features	11
Front Control Panel	12
Remote Control	
Overview	14
Battery Installation	15
Care	15
Sleep Timer	15
TV Back Panel	16
Memory Card Reader	18
System Reset Button	20
TV Reset Menu	20

Chapter 2: Connecting

External Devices and NetCommand® Setup	22
Using a CableCARD	23
Wall Outlet Cable	24
Standard Cable Box	24
Antenna with a Single Lead	25
Antennas with Separate UHF and VHF Leads	25
VCR to an Antenna or Wall Outlet Cable (Audio & Video)	26
VCR to a Cable Box (Audio & Video)	27
A/V Receiver (Stereo System)	28
Satellite Receiver or Other Device with S-Video	28
DVD Player with Component Video	29
DVI Device	29
HDTV Cable Box or Satellite Receiver with Component Video	30
HDMI Device	30
Computer with an HDMI Monitor Output	31
Computer with a DVI Monitor Output	31
IR Emitter NetCommand®	32
Compatible IEEE 1394 Devices	33
Helpful Hints for NetCommand Connections	35

Chapter 3: NetCommand® Setup and Editing

NetCommand® Introduction	38
Using the Remote Control with NetCommand®	39
NetCommand® Setup On-Screen Buttons	40
3D Graphical ▶ViewPoint® Menu System	41
NetCommand® Initial Setup	42
Edit NetCommand®: Add an A/V Receiver	45
Edit NetCommand®: Add Devices	48
Edit NetCommand®: Change or Delete Devices	52
IEEE 1394 Devices and NetCommand® Control	53
Adding IEEE 1394 Devices Automatically	54

Chapter 4: NetCommand® Functions

Device Selection Menu	58
Using the Device Menu Button to Display Menus	59
Using the GUIDE Button to Display ChannelView™ and Menus	60
NetCommand®-Controlled Recordings	61
Peer-to-Peer Connections	63
Using A/V Discs	64

Chapter 5: TV Menu Operations

Main Menu	66
Setup Menu	67
NetCommand® Menu	69
Record Menu	70
Channel Menu	72
Captions Menu	74
V-Chip Lock Menu	76
Audio/Video Menu	79
Audio Settings	80
Video Settings	81

Chapter 6: Additional Features

MediaCommand™ and Memory Card Playback	84
Operation of PIP and POP	86
TV Display Formats	87
PC Viewing	89
PC Display Formats	90

Chapter 7: Troubleshooting

Appendices

Appendix A: Specifications	100
Appendix B: On-Screen Information Displays	102
Appendix C: Bypassing the V-Chip Lock	103
Appendix D: Remote Control Programming Codes	105
Appendix E: Device Control with NetCommand®	108
Appendix F: NetCommand® Specialized Device Keys	110
Appendix G: Cleaning and Service	111
Appendix H: Lamp Cartridge Replacement	112
Appendix I: Recording and Viewing Combinations	114

Trademark and License Information

Mitsubishi DLP™ Projection Television Limited Warranty

Index

Our Thanks...

Thank you for choosing Mitsubishi as your premier Home Entertainment provider

This Owner's Guide describes the features and functions of your Mitsubishi widescreen, high definition TV. We urge you to examine this Owner's Guide to become familiar with the innovative features and operations this unique television offers.

The very core of our corporate philosophy is to provide our customers with the very best. Our development team at Mitsubishi has worked to provide you with a television that defines "state-of-the-art," with the capability to meet your needs now and in the future.

Whether this is your first Mitsubishi electronic product, or an addition to your Mitsubishi collection, we believe you and your family will continue to enjoy your Mitsubishi home theater for many years.

Thank you,

Mitsubishi Digital Electronics America, Inc.

Chapter . . .



Television Overview

TV Accessories	10
Special Features.	11
Front Control Panel.	12
Remote Control	
Overview	14
Battery Installation	15
Care	15
Sleep Timer	15
TV Back Panel	16
Memory Card Reader	18
System Reset Button	20
TV Reset Menu.	20

TV Accessories

Please take a moment to review the following list of items to ensure that you have received everything.

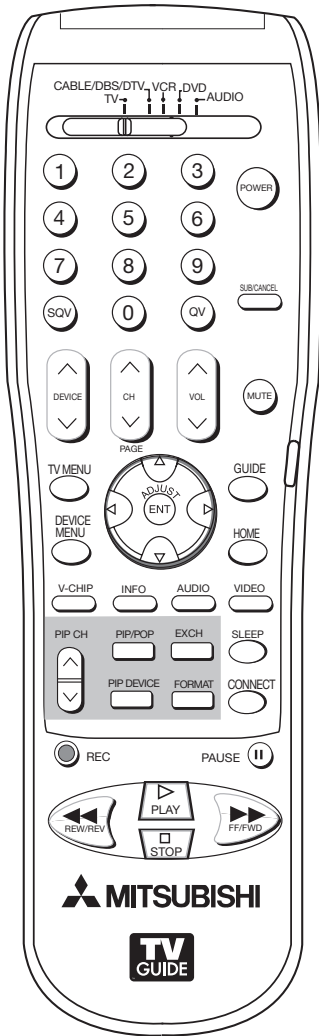

1. Remote Control

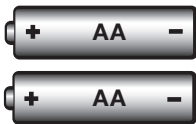

2. Two AA Batteries

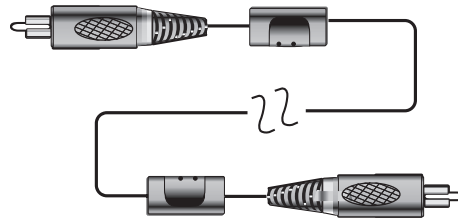

3. One Digital Audio Cable (sends the audio of digital channels to a digital audio/video receiver).

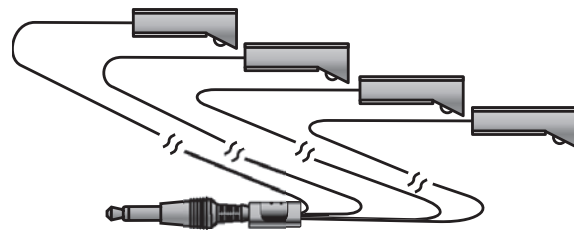

- 4. One Four-Headed IR Emitter Cable (allows NetCommand and TV Guide On Screen® to control other devices)
- 5. Product Registration Card (not pictured)
- 6. Owner's Guide (not pictured)
- 7. Quick Reference Card (not pictured)
- 8. TV Guide On Screen® Interactive Program Guide User's Manual (not pictured)

Special Features

Your new High Definition widescreen television has many special features that make it the perfect center of your home entertainment system, including:

High Definition DLP™ Display System

Your widescreen Mitsubishi HDTV uses Texas Instruments most advanced Digital Light Processing™ technology for rear projection televisions. This TV is truly a high-performance multimedia monitor uniquely capable of both stunning high-definition video images and clear, detailed, high-resolution PC images. Your TV is able to accept video signals from an antenna or direct cable in standard video scanning rates of 480i, 480p, 720p, 1080i and 1080p. It is also able to accept, through the HDMI 2 connection, signals with PC resolutions from VGA (640 x 480) through XGA (1024 x 768). When used with a compatible graphics card and controlling software, this TV is also able to accept the custom PC resolution of 720p (1280 x 720). To connect a PC to HDMI 2, you need a PC video card with DVI or HDMI output. Next you need to perform NetCommand setup for the HDMI 2 PC input so that the TV knows to apply the correct PC-signal processing. All of the compatible video and PC signals will be converted to 1080p for final display; some signals will, however, add black side bars, top and bottom bars, or both to fill the screen, and some signals will display standard video overscan.

TV Guide On Screen® Interactive Program Guide System

An eight-day on-screen program guide that can be used with cable, over-the-air and CableCARD™ reception. The subscription-free guide system lists regular, digital and high-definition programming. This system allows multiple sorting options and easy program recording. Program listings are downloaded while your TV is turned off, so that you have current program information available every day. Note that when the system is first set up, it may take up to 24 hours to begin to receive TV program listings. It may take one week to receive all eight days of TV program listings.

Digital Cable Ready (CableCARD™)

Your widescreen Mitsubishi HDTV is “Plug-and-Play” ready. It can descramble a cable provider’s one-way digital signals with the use of a CableCARD security module. The CableCARD is used in place of a traditional cable box to access digital cable programming (including high definition). Contact your local cable provider for availability information and service details.

NetCommand® Home Network Control System

Your widescreen Mitsubishi HDTV offers a new level of networking to combine selected older products with new and future digital products. NetCommand supports IEEE 1394 connections, Audio Video Control system (AV/C), 5C copy protection and IR control of selected older products such as VCRs, DVD players, cable boxes or satellite receivers. NetCommand includes the ability to learn remote control signals directly from many devices, allowing you to customize the NetCommand system in a way that works best for your viewing

16:9 Widescreen Picture Format

Enjoy a full theatrical experience in the comfort of your home. View pictures as film directors intended them. Digital TV broadcasts, DVDs and newer video game consoles support this widescreen format.

Memory Card Reader

You can display a slide show of your favorite JPEG pictures or listen to MP3 or WMA audio selections that have been recorded on compatible memory cards.

Front Control Panel

The shaded buttons on the front control panel are duplicated on the remote control. The top row of labels shows the control functions when there are no TV menus displayed on the screen. The bottom row of labels shows the control functions when the TV menus are displayed on the screen or when a special function has been activated. See “Remote Control Overview” for further details on the functions of these buttons.

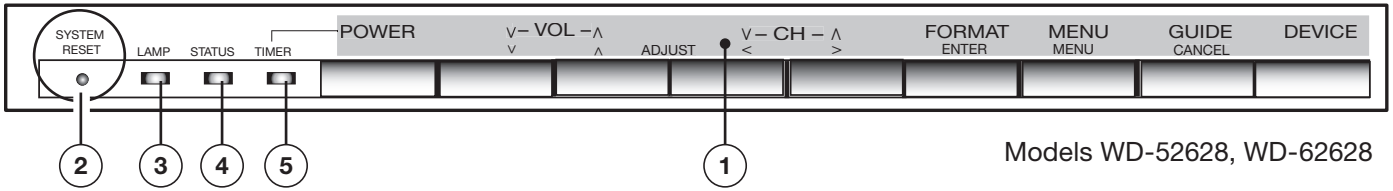

Models WD-52628, WD-62628

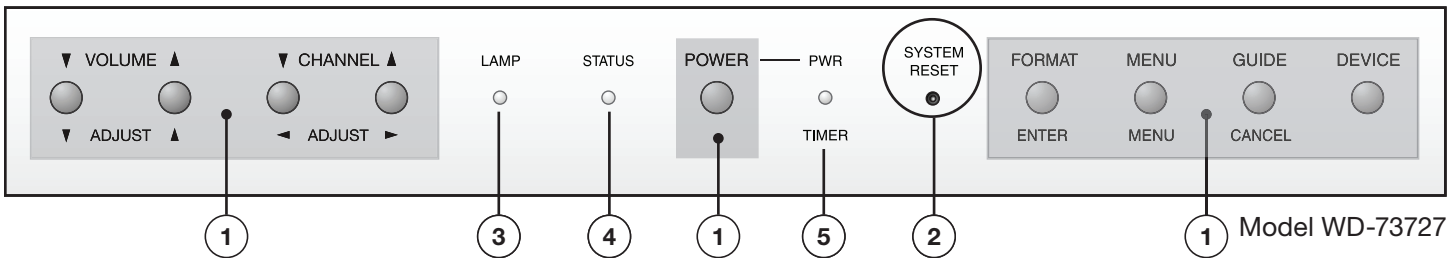

Model WD-73727

Front Control Panel

1. Shaded buttons duplicate buttons on the remote control
2. System Reset
3. Lamp indicator
4. Status indicator
5. Power/Timer indicator

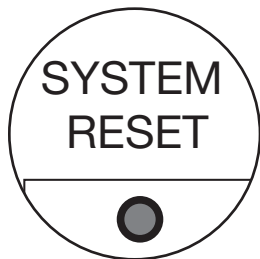

If the TV does not respond to either the remote control or the front panel controls and/or does not power off, press the SYSTEM RESET button with a pointed item, such as the end point of a paperclip. The TV will turn off and the TIMER light will flash quickly for about one minute. When the TIMER light stops flashing, you may again turn on the TV. The changes you made the last time the TV was on before you used the SYSTEM RESET button may be lost. Any changes that you previously saved are not lost.

Front-Panel Indicator Lights

Lamp Indicator		
Indicator Color	TV Condition	Additional Information
None (indicator off)	Normal TV on or standby condition.	Normal operation.
Green, rapid blinking	TV just powered off and lamp is cooling.	Begins to blink 30 seconds after turning off TV. TV can be turned on before it begins to blink or after the blinking stops, but not while the indicator is blinking. Normal operation.
Yellow, steady	Lamp nearing end of useful life.	This is a recommendation to have a new lamp ready before the current lamp stops illuminating. See Appendix H for ordering information.
Yellow, blinking	1. Lamp access door is open or not secure.	TV will not operate until lamp access door is secure. See Appendix H for installation information.
	2. No lamp installed.	TV will not operate without a lamp. See Appendix H for installation information.
Red, steady	Lamp no longer illuminates and has reached the end of the lamp life.	Replace the lamp. The TV will not operate when the lamp no longer illuminates. See Appendix H for installation information.

Front Control Panel, continued

Status Indicator		
Indicator Color	TV Condition	Additional Information
None (indicator off)	Normal TV on or standby condition.	Normal operation.
Yellow , steady	Room temperature is too high.	TV will not operate when the ambient room temperature is too high. Turn off the TV and wait until the room temperature drops.
Red , either steady or blinking	TV may require service.	Turn off the TV and unplug the set from the AC power source. Wait one minute and then plug the set back in. If the LED is still on, contact your dealer or a Mitsubishi Authorized Service Center. See www.mitsubishi-tv.com or call 1-800-332-2119 to receive Authorized Service Center information.

Power/Timer Indicator		
Indicator Color	TV Condition	Additional Information
None (indicator off)	TV is powered OFF.	Normal operation.
Green , steady	TV is powered ON.	Normal operation.
Green , rapid blinking	1. TV just plugged into AC outlet.	Wait until blinking stops before turning on (approximately 1 minute). Normal operation.
	2. AC just restored after power failure.	Wait until blinking stops before turning on (approximately 1 minute). Normal operation.
	3. TV Rebooting after System Reset used.	Wait until blinking stops before turning on (approximately 1-2 minutes). Normal operation.
	4. TV Rebooting after power fluctuation or receiving abnormal digital signals from digital channel, CableCARD™, or digital device.	Wait until blinking stops before turning on (approximately 1 minute). Normal operation.
	5. You have begun the procedure to update software from an authorized flash memory device.	For detailed information, see the instructions that accompany the authorized software update. Important: Do not use non-authorized software at any time.
Green , slow blinking	TV powered off and automatic-on timer is set.	Normal operation. TV can be turned on at any time.

A/V Reset

There may be times when you wish to reset the A/V (Audio and Video) settings back to the factory defaults. To return all the settings at once, press GUIDE and FORMAT on the front panel at the same time. To reset the defaults for individual devices, use the A/V Memory Reset selection on the Audio/Video menu.

Remote Control

Overview

Figure 1, following page

- 1. Slide Switch:** Selects the A/V product to be controlled by the remote control. Select TV for NetCommand® device control.
- 2. Numbers:** Individually select channels or enter information into menus.
- 3. SQV (SuperQuickView™):** Scans through memorized lists of favorite channels.
- 4. CH(ANNEL)/PAGE:** Scans up or down through memorized channels. Pages up and down through screens when used with TV Guide On Screen®, ChannelView™, a satellite receiver, some cable boxes, memory card playlists and JPEG thumbnails. Pages up and down through DVD chapters.
- 5. DEVICE:** Displays the Device Selection menu in which you can select the device to view (ANT-1 and ANT-2, or devices connected to the TV's inputs, including IEEE 1394 devices).
- 6. ADJUST:** Press ▲▼◀▶ to navigate menus, change settings, and move the PIP on-screen location. Operates many NetCommand® functions. Navigate TV Guide On Screen® and change settings.
- 7. TV MENU:** Displays the ▶ViewPoint on-screen menu system.
- 8. ENTER:** Selects a channel number or menu item.
- 9. DEVICE MENU:** Displays the menu for devices connected to the TV, including CableCARD™. For VCR or DVDs, the first press displays the transport menu, the second press displays the VCR or DVD menu. Displays and removes options menus for TV Guide On Screen. Opens the Media Dialog Box for memory cards.
- 10. INFO:** Press to display an on-screen summary of the current device used and any broadcast information available (including current V-Chip information). See Appendix B for details on the on-screen display. While in TV Guide On Screen, press repeatedly to cycle through the available info box sizes.
- 11. V-CHIP:** Turns the V-Chip Lock on or off.
- 12. PIP/POP:** Turns on PIP and cycles through PIP and POP display choices.
- 13. PIP CH:** Scrolls up or down through memorized channels for PIP
- 14. PIP DEVICE:** Displays PIP Selection menu to select the PIP or POP image source device
- 15. REC (Record):** Displays the Record menu for setting up recordings. Records with a VCR, sets up recordings for DVCR, IEEE 1394 devices, or while in ChannelView. Starts a recording when the Listings screen for TV Guide On Screen is displayed.
- 16. REW/REV:** Rewinds a VCR. Reverses scan with a DVD, A/V Disc, or memory card file.
- 17. POWER:** Turns power on and off for the TV and other A/V products.
- 18. QV (QuickView™):** Switches between the current channel and last channel viewed.
- 19. SUB/CANCEL:** When entering digital channel numbers, adds separator between main and sub-channel numbers. Clears SQV and some menu entries, and cancels recordings.
- 20. VOLUME:** Changes sound level.
- 21. MUTE:** Turns sound on or off.
- 22. GUIDE:** Displays or removes TV Guide On Screen or ChannelView for ANT-1 and 2. Displays Track List for A/V Disc. Displays program guide for satellite receiver and cable boxes, or DVD Disc menu. Displays thumbnails or playlists for memory card files.
- 23. Light:** Located on the right side of the remote control, this feature illuminates buttons or labels.
- 24. HOME:** Exits TV on-screen menus and the TV Guide On Screen system and returns to TV viewing.
- 25. AUDIO:** Selects individual audio settings for adjustment.
- 26. VIDEO:** Selects individual video settings for adjustment.
- 27. EXCH:** Exchanges PIP or POP and main TV picture.
- 28. SLEEP:** Sets the TV to turn off within 2 hours. See the next page for setup instructions.
- 29. CONNECT:** Initiates IEEE 1394 peer-to-peer connections.
- 30. FORMAT:** Changes the shape and size of the main TV picture.
- 31. PAUSE:** Pauses a live TV picture when no PIP or POP image is displayed. When PIP image is visible, pauses that image. Pauses a VCR, DVD, A/V Disc, or memory card file.
- 32. PLAY:** Plays a VCR, DVD, A/V Disc, or memory card file.
- 33. FF/FWD:** Fast forward a VCR or memory card file, or fast play a DVD or A/V disc.
- 34. STOP:** Stops play of a VCR, DVD, A/V Disc, or memory card file.

Remote Control, continued

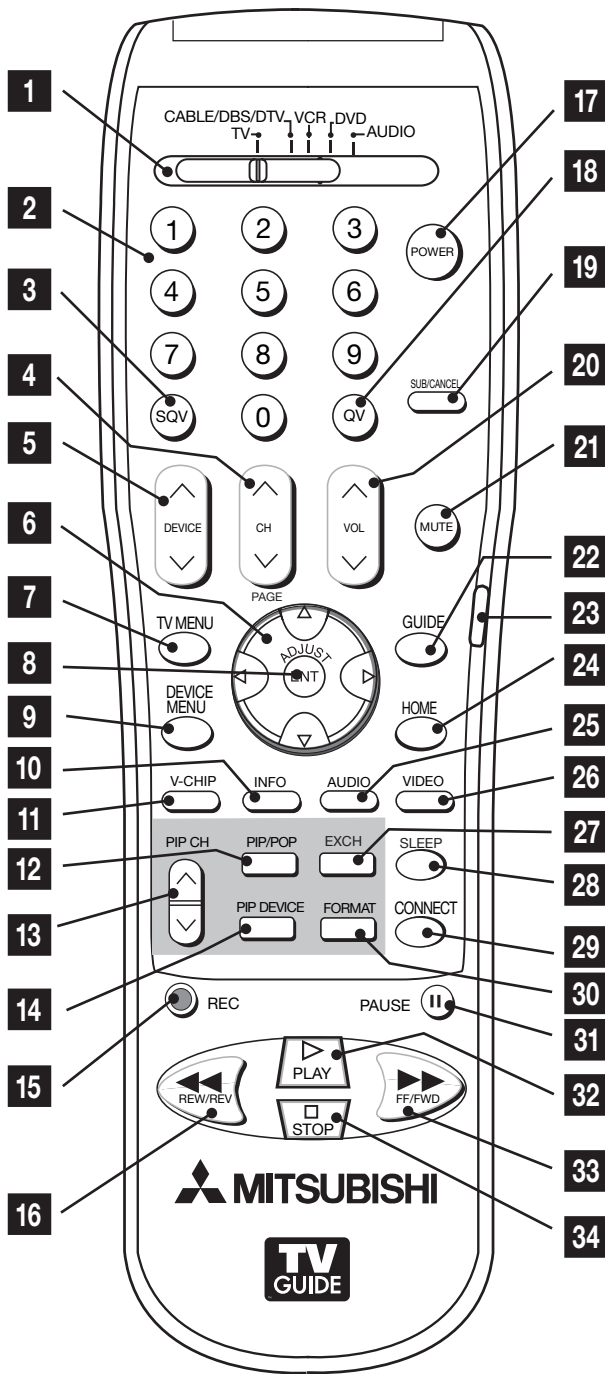

Figure 1. Remote Control Overview

- Load the batteries, making sure the polarities (+) and (-) are correct. For best results, insert the negative (-) side first.

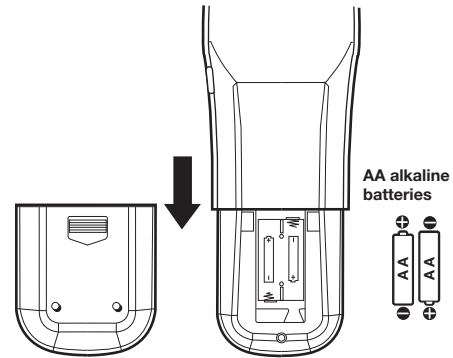

Figure 2. Operation: Installing the Batteries

Care

For Best Results from the Remote Control:

- Be within 20 feet of the equipment.
- Do not press two or more buttons at the same time unless instructed.
- Do not allow unit to get wet or become heated.
- Avoid dropping on hard surfaces.
- Do not use harsh chemicals to clean. Use only a soft, lightly moistened cloth.
- Do not mix new and old batteries.
- Do not heat, take apart, or throw batteries into fire.
- Use only AA alkaline batteries.

Hint: If the remote is in the TV layer and does not function, press POWER and 9, 3, 5 to reset the remote.

Sleep Timer

Setting the Sleep Timer:

- Press SLEEP on the remote control.
- Each additional press of SLEEP increases the time displayed by 30 minutes up until the maximum value of 120 minutes.
- After five seconds of inactivity, the message will disappear.
- Press SLEEP to view the time remaining before the timer turns the TV off.

Cancelling the Sleep Timer:

- Press SLEEP to display the on-screen message.
- Press SLEEP repeatedly until OFF is displayed.

Note: After five seconds of inactivity, the message box disappears.

Battery Installation

Figure 2

Installing the Batteries:

- Remove the remote control's back cover by gently pressing the ribbed tab in the direction of the arrow and sliding off the cover.

TV Back Panel

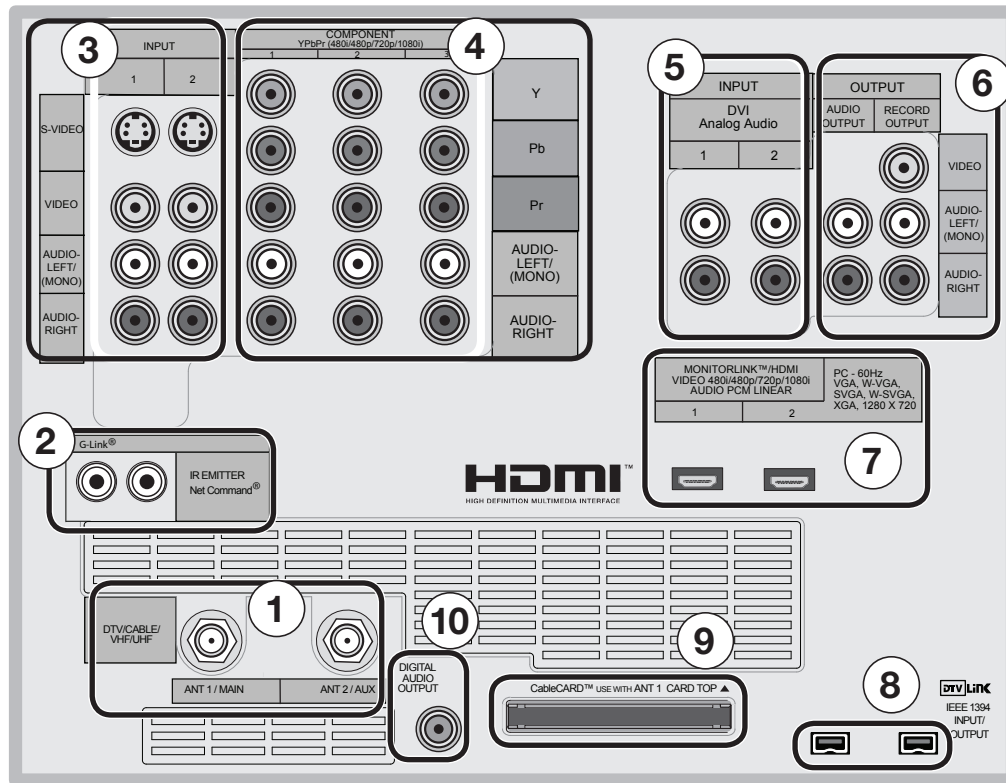

1. Antenna (ANT-1 MAIN, ANT-2 AUX)

ANT-1 MAIN and ANT-2 AUX can each receive both digital and analog over-the-air channels from a VHF/UHF antenna or non-scrambled digital/analog cable source.

Your primary viewing signal source should be connected to ANT-1 MAIN. ANT-1 MAIN must be used to view premium subscription cable TV service authorized by the CableCARD™ access card. The CableCARD access card is provided by your local cable company. ANT-2 AUX can receive over-the-air or non-scrambled cable signals.

2. IR EMITTER NetCommand®

IR Emitters connected to these jacks are used by the NetCommand system of the TV to control external analog devices such as cable boxes, VCRs, DVDs, satellite receivers and audio receivers. This system is also coordinated with the TV Guide On Screen® system for the control of cable boxes and to activate the record feature of your VCR. Either connection can be used for NetCommand functions.

3. INPUT 1 and 2 (Audio/Video 1 and 2)

Inputs 1 and 2 can be used for the connection of a VCR, Super VHS (S-VHS) VCR, DVD player, standard satellite receiver or other A/V device to the TV. Please note that if S-VIDEO and VIDEO are available for the input, you

must choose to connect only one. They cannot both be connected at the same time.

4. COMPONENT 1, 2, and 3 Inputs YPbPr (480i/480p/720p/1080i)

These inputs can be used for the connection of devices with component video outputs, such as a DVD player, external HDTV receiver, or compatible video game system. Please see Appendix A for signal compatibility.

5. DVI Analog Audio

Unlike HDMI, DVI does not carry audio information on the same cable. Use these analog stereo audio inputs when using the HDMI input with a device that outputs DVI instead of HDMI, such as DVI output from a personal computer.

6. AUDIO OUTPUT, RECORD OUTPUT

AUDIO OUTPUT sends analog audio of the program currently shown on the screen to an A/V surround sound receiver or stereo system. Digital audio from digital channels, FireWire® (DTV Link/IEEE 1394) devices and HDMI devices is converted to analog audio by the TV. If you do not have a digital A/V receiver, this should be the only audio connection between the TV and your analog A/V receiver or stereo system.

RECORD OUTPUT sends analog audio and video to a VCR for recording purposes. These signals may not be the same as those of the program that is currently

TV Back Panel, continued

being shown on screen. Signals from digital channels and FireWire (IEEE 1394) devices are converted to analog signals. There is no video signal when copy restrictions are in effect. Audio alone is output when a Component input or the HDMI input is selected for recording.

7. HDMI™ 1 and 2

The HDMI (High Definition Multimedia Interface) supports uncompressed standard and high-definition digital video formats and PCM digital audio format.

Use these inputs to connect to EIA/CEA-861 compliant devices such as a high-definition receiver or DVD player. These inputs support 480i, 480p, 720p and 1080i video formats.

These inputs can also be used as a DVI connection with separate analog audio inputs. An optional HDMI-to-DVI adaptor or cable is necessary to make this connection and may be available from your local electronics retailer. When using the optional HDMI-to-DVI adapter, the DVI analog audio inputs on your TV allow you to receive left and right audio from your DVI device.

This input is HDCP (High-Bandwidth Digital Copy Protection) compliant.

HDMI 2

HDMI 2 also allows the TV to display DVI or HDMI output from a PC. To view PC video on the TV, you must activate the PC option in NetCommand. You can do this during initial NetCommand setup by selecting the PC option in the Device Setup screen. To do this at any time afterwards, use the NetCommand Add function.

To listen to audio from a PC when using PC DVI output, you must connect the PC audio output to the TV's DVI Analog Audio 2, located above the HDMI 2 input.

8. DTV Link™/IEEE 1394

These jacks allow the TV to connect to external IEEE 1394 digital products by means of a single cable. Two jacks are provided for this purpose, which allow for a high degree of flexibility for connecting your NetCommand controlled system. Detailed information regarding IEEE 1394 connection requirements is in Chapter 2, "Connecting."

9. CableCARD™ Slot

The CableCARD access card from your cable TV service provider is inserted into this slot. The top of the card should face in the direction indicated by CARD TOP ▲.

CableCARD is a nationwide standard system that allows your local cable TV provider to supply you with an access card customized to your account. This card allows the TV to receive, decode and unscramble the premium digital channels included in your cable TV subscription without the use of a cable box. See page 23 for additional CableCARD information and activation instructions.

If your cable company is not currently offering CableCARD access cards, you will need to use a cable box provided and authorized by your local cable company to view scrambled channels.

10. Digital Audio Output

This output sends Dolby® Digital or PCM digital audio to your digital A/V surround sound receiver. Analog audio from analog channels and devices is converted by the TV to PCM digital audio. In most cases, this should be the only audio connection between the TV and your A/V receiver. If you have MP3 audio from memory cards, however, you need to connect the TV's analog AUDIO OUTPUT (left and right) to your A/V receiver.

Memory Card Reader and Front-Panel Inputs

Memory Card Reader

Figure 3

The memory card reader has four card slots that allow the display of JPEG pictures from many digital cameras and allow you to listen to MP3 or WMA audio files recorded from computers or other digital recording devices.

The card slots are designed for the specific types of cards listed below. Other cards or objects should not be inserted into the slots as this may damage the TV. See the discussion of memory cards in chapter 6 for details about JPEG, MP3 and WMA file types that are compatible with the TV.

Card Compatibility

Slot	Card Types
CARD 1	SmartMedia™
CARD 2	MultiMediaCard™ Secure Digital (SD)
CARD 3	CompactFlash® (Types I and II) Microdrive®
CARD 4	Memory Stick PRO™ Memory Stick™

Models WD-52628, WD-62628

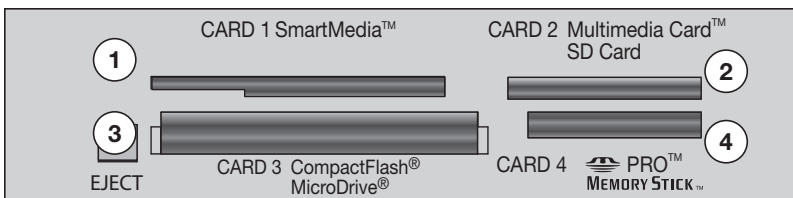
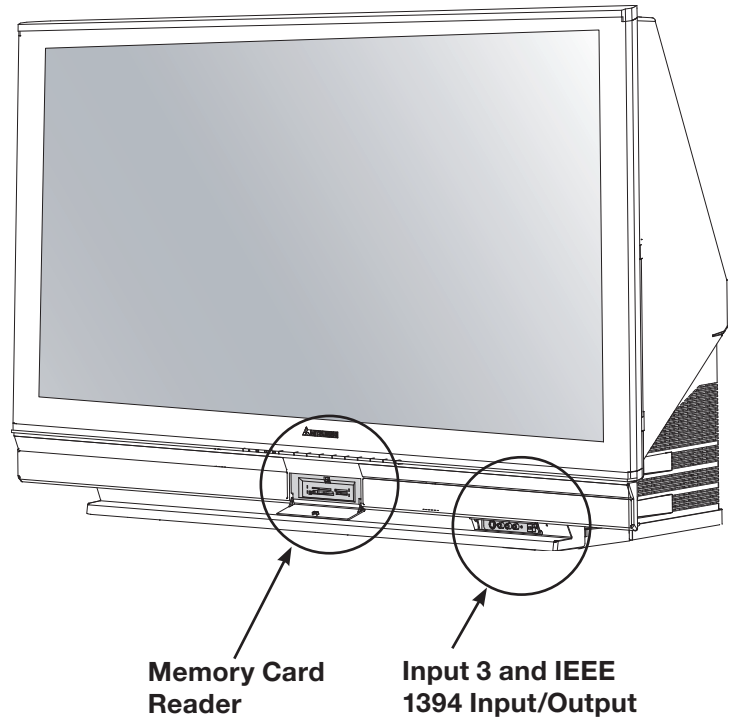

Figure 3. Memory Card Reader

IMPORTANT

Portions of the advanced circuitry of this TV must continue to operate even when the TV is turned off. Some of these circuits therefore need to be cooled at all times. A low-power standby fan may be heard in a quiet environment. This is normal operation.

Memory Card Reader and Front-Panel Inputs

Input 3 and IEEE 1394 Input/Output

Figure 4

These jacks allow for convenient connection of audio/video devices to the front of the TV.

Note that if you connect to the S-VIDEO terminal, the VIDEO terminal is deactivated. The VIDEO terminal is active only when there is no S-Video connection.

Use the IEEE 1394 input/output to connect IEEE 1394 devices, such as some camcorders. This connection works the same as the rear IEEE 1394 connections. Please refer to the NetCommand® information (Chapter 3) for details.

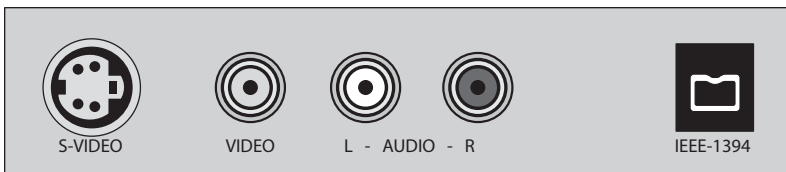
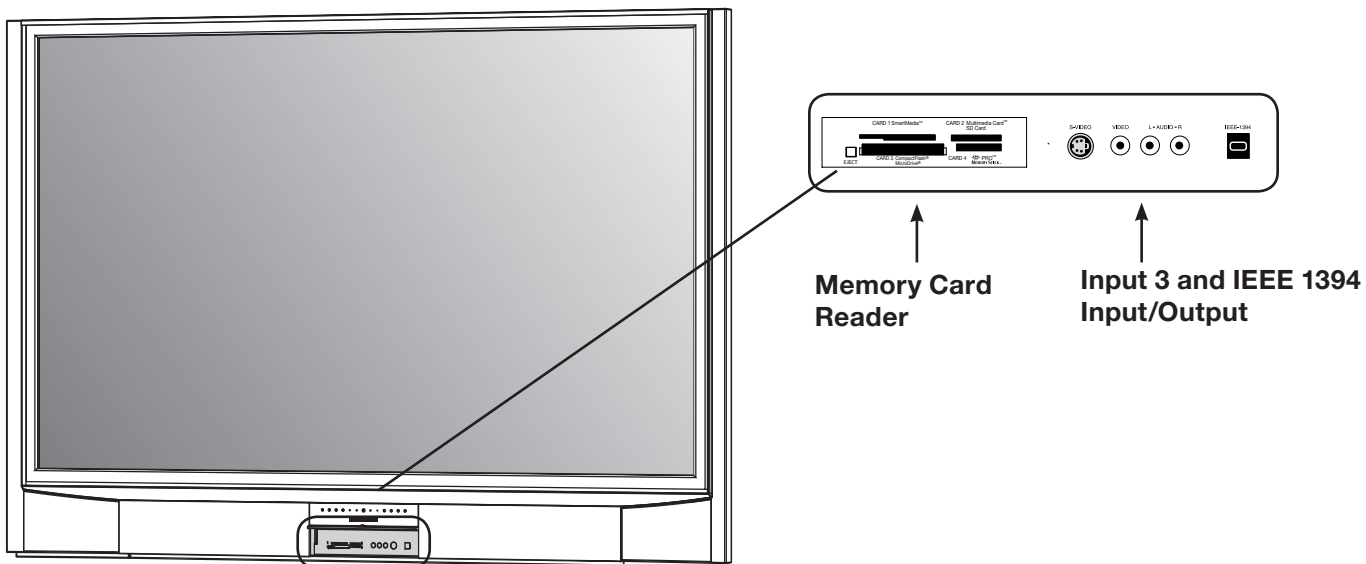

Figure 4. Input 3 and IEEE 1394 input/output on front panel

Model WD-73727



Additional Information

System Reset Button

If the TV doesn't respond to either the remote control or the front panel controls or will not power off, press the SYSTEM RESET button on the front panel with a pointed item such as the point of a ball point pen or end tip of a paperclip.

The TV will turn off and the green LED will flash quickly for about one minute. When the green LED stops flashing, you may turn on the TV again. The changes you made while the TV was most recently on, before you used the SYSTEM RESET button, may be lost; the changes you made previously, however, are not lost. Only those changes since the last power on may be lost when the system reset button is pressed. All other settings are retained.

TV Reset Menu

Read on-screen warnings before proceeding, as some user data or settings may be erased.

1. Press TV MENU and then 1, 2, 3 to see the RESET SERVICE MENU to reset the TV.
2. Select Reset System Defaults (**CAUTION:** All settings, except V-Chip, will be reset to the original factory defaults).

Demo Mode

This TV has a demo mode for use in retail stores. To turn the demo mode On/Off, press the following buttons in sequence:

MENU, 0, QV, 0

IMPORTANT

Do not attempt to update the software of this TV with software or cards that are not provided by or authorized by Mitsubishi Digital Electronics America, Inc. Non-authorized software may damage the TV and will not be covered by the warranty.

Connecting

External Devices and NetCommand® Setup	22
Using a CableCARD	23
Wall Outlet Cable	24
Standard Cable Box	24
Antenna with a Single Lead	25
Antennas with Separate UHF and VHF Leads.	25
VCR to an Antenna or Wall Outlet Cable (Audio & Video)	26
VCR to a Cable Box (Audio & Video)	27
A/V Receiver (Stereo System)	28
Satellite Receiver or Other Device with S-Video	28
DVD Player with Component Video	29
DVI Device	29
HDTV Cable Box or Satellite Receiver with Component Video	30
HDMI Device	30
Computer with an HDMI Monitor Output	31
Computer with a DVI Monitor Output	31
IR Emitter NetCommand®	32
Compatible IEEE 1394 Devices.	33
Helpful Hints for NetCommand Connections	35

Connecting External Devices and NetCommand® Setup

NetCommand is able to control many current audio and video devices by sending remote control signals from the TV to each device through IR emitters. Additionally, it can learn the remote control signals used by most audio video devices not already in the TV's memory. NetCommand can automatically switch the TV and compatible or learned Audio/Video (A/V) Receivers to the correct input used with each device. It is important that the inputs on the TV and A/V receiver back panels match the NetCommand setup that is displayed on screen.

To simplify the installation of NetCommand, there is a step-by-step on-screen NetCommand Setup procedure in this chapter, which details the type and brands of devices you are connecting to the TV. The NetCommand Setup also assigns preset TV and A/V receiver inputs for each device. You should connect each device to the TV input (both audio and video) and to the A/V receiver (audio) as shown in the figure below. If you connect devices to inputs other than the ones shown as presets, you must change the NetCommand setup accordingly. See the Edit NetCommand information starting on page 45.

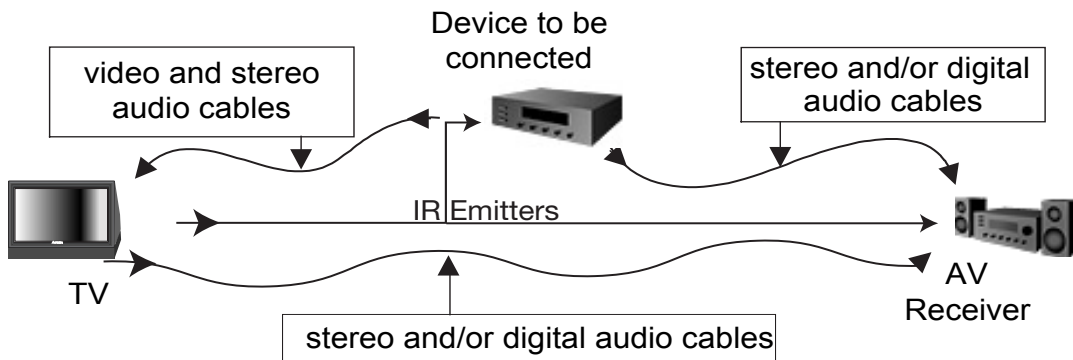

The following charts show which preset inputs you should use on the TV and A/V receiver.

Chart 1 shows the default TV inputs existing in NetCommand.

Chart 2 shows the A/V receiver inputs used by A/V receiver models already known by NetCommand.

Chart 1	
NetCommand Default Device Audio and Video Outputs to TV Inputs	
Cable for CableCARD™ Service	ANT-1
Antenna/Cable (digital/analog)	ANT-1 if primary viewing source, ANT-2 if secondary viewing source
Cable box	COMPONENT-1
VCR	Input-1
Satellite Receiver (SAT)	Input-2
Camcorder	Input-3 (on front panel)
DVD Player	COMPONENT-2
PC	HDMI-2

Chart 2	Mitsubishi 1	Mitsubishi 2	Bose	Denon	Integra	Kenwood	Marantz	Pioneer 1	Pioneer 2	Rotel	Sony	Yamaha 1	Yamaha 2
	Model M-VR800 & M-VR1000	Model M-VR900 & M-VR700	Model Lifestyle @28	Model AVR-2700	Model DTR-9.1	Model VR-2080	Model SR8200	Model VSX-D557	Model VSX-49TX	Model RSX-1065	Model STR-DE825	Model RX-V2095	Model RX-V2200
Device Audio Output to	AV Receiver Inputs by Name												
VCR	VCR 1	VCR	VCR	VCR-1	Video 1	Video 1	VCR1	VCR/Tape	VCR 1/DVR	Video 2	Video 1	VCR 1	VCR 1
Satellite Receiver	Aux	Cable/DBS	AUX	CD	Video 3	Video 3	DSS	CD	SAT	Video 4	TV/DBS	TV/DBS	D-TV/LD
DVD Player	DVD	DVD	(built-in)	DVD/DVP	DVD	Video 4	DVD	LD/SAT	DVD/LD	Video 5	TAPE/MD	CD	DVD
TV Monitor Output (& Digital Audio)	TV	TV	TV	TV/DBS	Video 4	Video 4	TV	DVD/TV	TV	Video 1	DVD/LD	DVD/LD	CBL/SAT

After using NetCommand Setup, you may go to the NetCommand menu at any time to change the inputs you used for connecting each device, custom name devices, add devices not included in the presets above or delete devices no longer used. See *Edit NetCommand*. See *Helpful Hints* at the end of this chapter for additional information on device setup.

Using a CableCARD

Using a CableCARD

After inserting a CableCARD into the TV back panel CableCARD slot and powering On the TV, the initialization process begins. An initial screen will automatically display for a few minutes, with information that your Cable Provider will need in order to start service. Please write down this information before calling your cable provider.

Please call XYZ Cable
at xxx-xxx-xxxx to
activate cable service.

They will need these numbers:
Host ID X-XXX-XXX-XXX-XXX
CableCARD™ ID: X-XXX-XXX-XXX-XXX

See owner's manual for
further information

An example of an initial screen is shown here. Your screen will display specific information from your cable provider and may not look like this screen.

If you were unable to record the information, you can press TV MENU on the remote and then enter the number 999 and the screen will re-display. You can also press DEVICE MENU when the CableCARD is the selected source and you will be able to select the startup application.

IMPORTANT

To use a CableCARD, the primary incoming cable must be connected to ANT-1 MAIN.

CableCARD Technology

CableCARD is a nationwide system standard that allows your local cable TV provider to supply you with an access card customized to your account. This card allows your TV to receive, decode and unscramble the premium digital channels included in your cable TV subscription without the use of a cable box. It also allows your cable provider to automatically update and change your subscription. When you move to a new cable provider's area, you simply return the CableCARD to the original cable provider and get a new card from your new cable provider.

Please note that CableCARD is a new technology and your local cable provider may not currently be offering this service. As time passes, this system will become broadly supported by most cable providers.

The CableCARD system is "unidirectional" which means your cable provider can send updates to the access card and TV, however, the TV cannot send back signals such as requests for Video-On-Demand or Pay-per-View programs by remote control.

Digital cable channels authorized by the CableCARD will be available on the Firewire® IEEE 1394 network and can be shared by other products on the network. Some digital channels or programs may not be copied or recorded because of copy restriction limits set by the content owners or copyright holders.

The digital television is capable of receiving analog basic, digital basic, and digital premium cable television programming by direct connection to a cable system providing such programming. A security card (CableCARD) provided by your cable operator is required to view encrypted digital programming. Certain advanced and interactive digital cable services, such as video-on-demand, a cable operator's enhanced program guide, and data-enhanced television services, may require the use of a set-top box. For more information, call your local cable operator.

Please see page 17 for instructions on how to insert the CableCARD.

Connecting a Wall Outlet Cable or Cable Box

Wall Outlet Cable (can be used with a CableCARD™)

Figure 1

It is very important to connect the incoming cable for your primary viewing source to ANT-1, especially for CableCARD™ use and to download TV Guide On Screen® listings.

1. Connect the primary incoming coaxial lead cable to ANT 1/MAIN on the TV back panel.
2. For an optional secondary antenna source, connect an antenna (or cable) to ANT 2/AUX.
3. If you have subscribed to a CableCARD™ service, the CableCARD can now be inserted into the CableCARD SLOT. Using a Phillips screwdriver, remove the CableCARD cover screws. Insert the CableCARD, then replace the cover and screws. The top of the card should face in the direction the CARD TOP arrow indicates.

Additional CableCARD information is on page 23. Detailed TV Guide On Screen information is in the separate User's Manual.

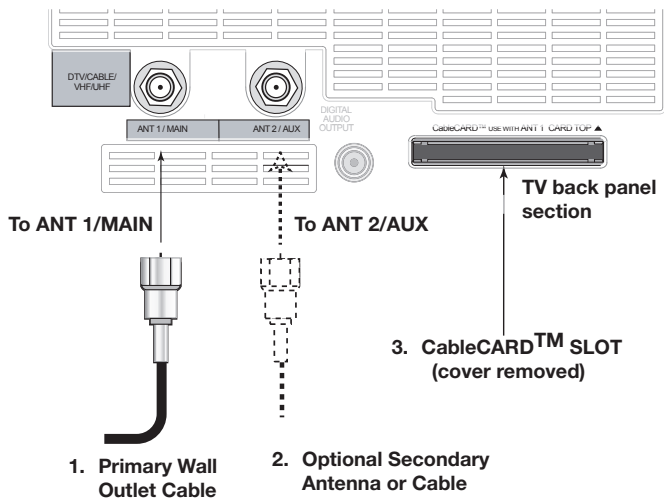

Figure 1. Wall Outlet Cable

Standard Cable Box

(cable box, other than an HDTV cable box; this setup allows two-channel PIP)

Figure 2

3 coaxial cables and one two-way RF splitter are required. These are not included with the TV.

Note: See page 30 to connect an HDTV cable box.

1. Connect the incoming cable to IN on an RF splitter.
2. Connect one coaxial cable from OUT on the RF splitter to ANT-1 MAIN on the TV back panel.
3. Connect one coaxial cable from OUT on the RF splitter to IN on the standard cable box.
4. Connect one coaxial cable from OUT on the cable box to ANT-2 AUX on the TV back panel.
5. After the cable box is connected to ANT-2 AUX as shown, use the NetCommand menu Change option to change the default connection for the cable box, go to the RF Connection for Cable screen and do the following:
 - a. Check the RF check box.
 - b. For antenna, select ANT-2.
 - c. For Channel, select the channel to which the TV must be tuned for your cable box. The default channel is 3.

When this setup is complete, you can use the TV remote control to change channels on the cable box.

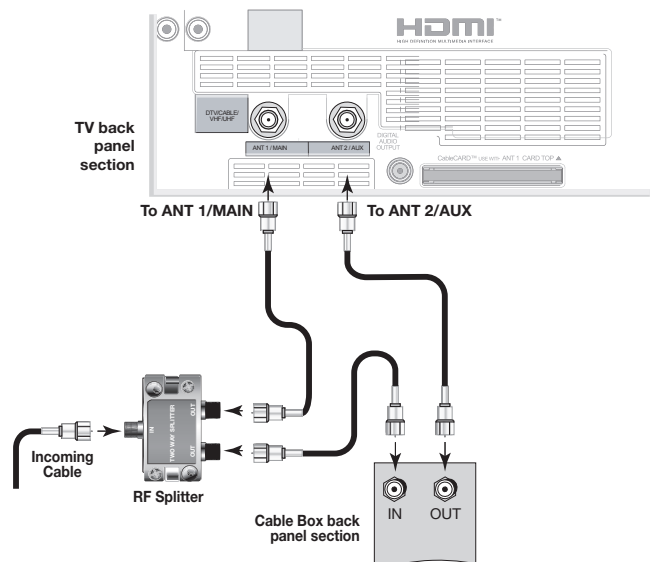

Figure 2. Connecting a Cable Box

IMPORTANT

Additional connection cables are not provided with the TV. They are available at most electronics stores.

Note: To use a cable box connected to ANT-2 as shown above, you must make the noted NetCommand changes. The changes are required to change the NetCommand cable-box default connection (Component-1) to the actual connection (ANT-2).

Connecting an Antenna with a Single Lead or Antennas with Separate UHF and VHF Leads

Antenna with a Single Lead

(not for use with CableCARD™)

Figure 3

For antennas with flat twin leads

A 300-ohm-to-75-ohm transformer is required. This is not included with the TV, but is available at most electronics stores.

1. For an antenna with flat twin leads, connect the 300-ohm twin leads to the 300-ohm-to-75-ohm transformer.
2. Push the 75-ohm side of the transformer onto ANT-1 MAIN on the TV back panel.

For cable or antenna with coaxial lead

Connect the coaxial lead directly to ANT-1 MAIN on the TV back panel.

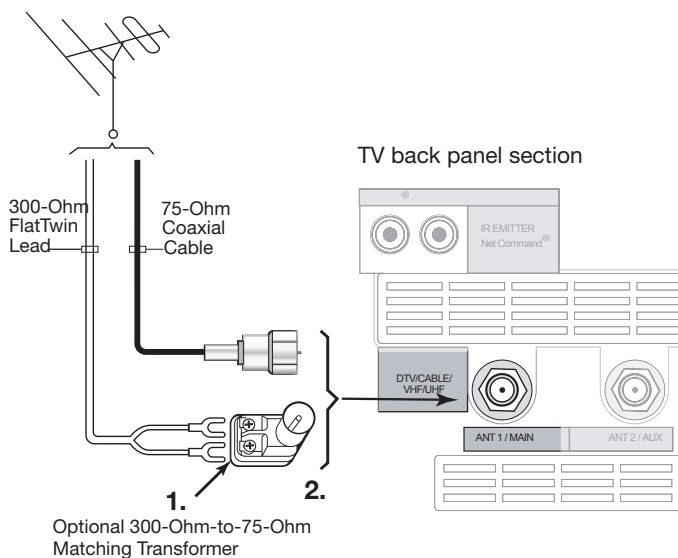

Figure 3. Connecting a Single Antenna

Antennas with Separate UHF and VHF Leads

Figure 4

A UHF/VHF combiner is required. This is not included with the TV, but is available at most electronics stores.

1. Connect the UHF and VHF antenna leads to the UHF/VHF combiner.
2. Push the combiner onto ANT-1 MAIN on the TV back panel.

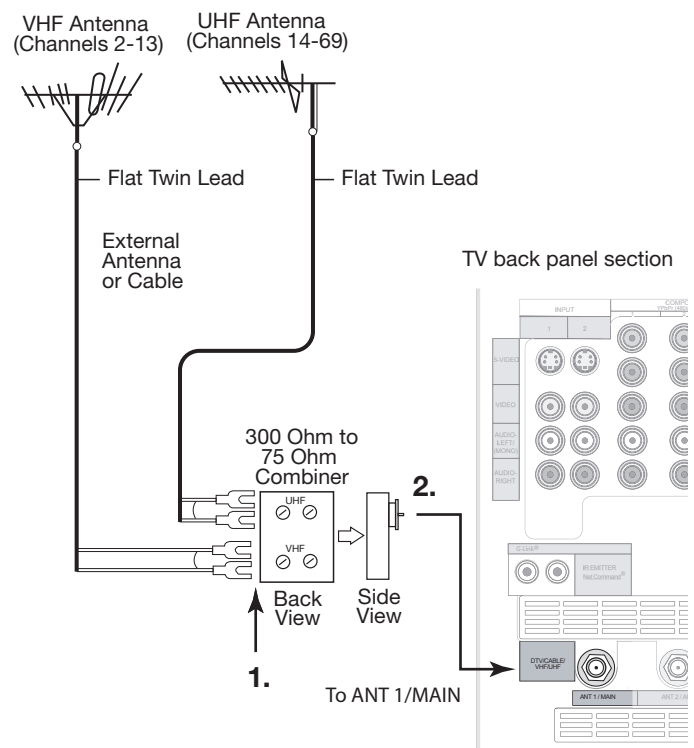

Figure 4. Connecting separate UHF and VHF Antennas

Mitsubishi strongly recommends you avoid using antennas with flat twin leads. Flat twin lead antenna wires are subject to interference which may adversely affect the performance of the TV. We recommend using coaxial antenna cable.

Connecting a VCR to an Antenna or Wall Outlet Cable

Connecting VCR Audio and Video to the TV

VCR to an Antenna or Wall Outlet Cable (Audio & Video)

Figure 5

A two-way RF splitter, 3 coaxial cables, right and left audio cables, and an S-video or video cable are required. These are not included with the TV but are available at most electronics stores.

1. Connect the incoming cable or Antenna to IN on the RF splitter.
2. Connect one coaxial cable from OUT on the RF splitter to ANTENNA IN on the VCR back panel.
3. Connect one coaxial cable from OUT on the RF splitter to ANT-1 MAIN on the TV back panel. This connection also allows you to use the TV Guide On Screen® feature.
4. To use the TV speakers with the VCR, connect a set of audio cables from AUDIO OUT on the VCR back panel to INPUT-1 AUDIO-LEFT (MONO) and AUDIO-RIGHT on the TV back panel. The red cable connects to the R (right) channel and the white cable connects to the L (left) channel. If your VCR is mono (non-stereo), connect only the white (left) cable.
5. Connect either an S-Video or Video cable from VIDEO OUT on the VCR back panel to INPUT-1 VIDEO on the TV back panel. Only one type of video cable should be connected. S-Video is recommended, if available.
6. For NetCommand®-controlled recordings (including TV Guide On Screen), connect a set of audio cables from AUDIO IN on the VCR back panel to RECORD OUTPUT/AUDIO-LEFT and AUDIO-RIGHT on the TV back panel. The red cable connects to the R (right) channel and the white cable connects to the L (left) channel.
7. Complete the NetCommand controlled recordings connections by connecting a Video cable from VIDEO IN on the VCR back panel to RECORD OUTPUT/VIDEO on the TV back panel.

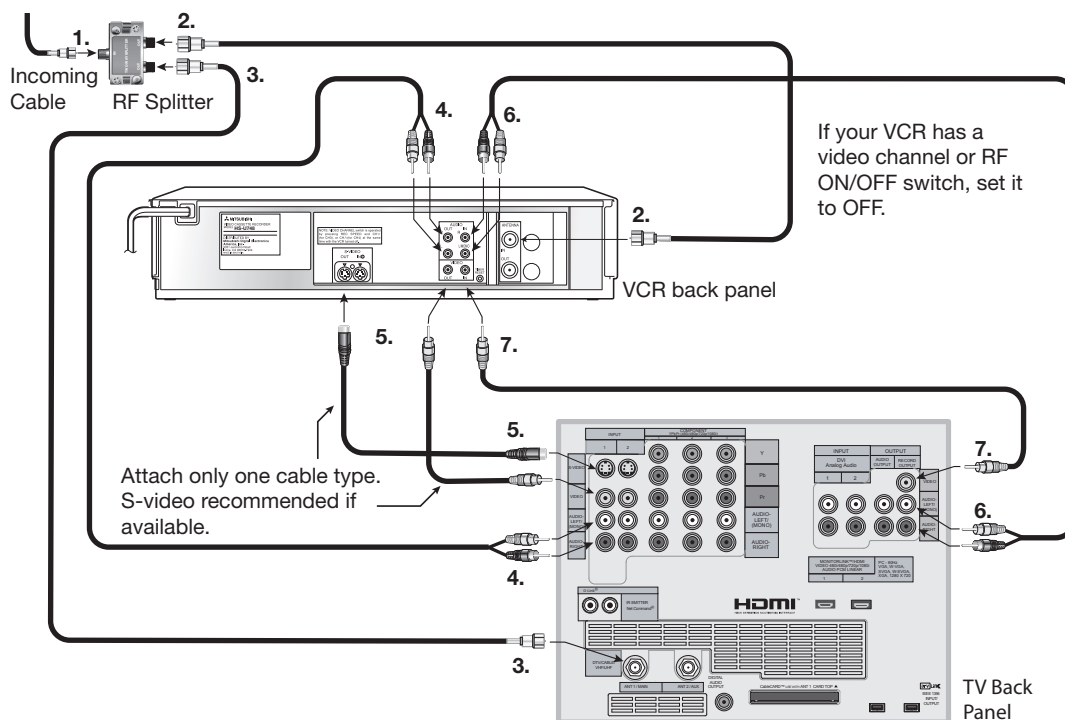

Note: NetCommand® will assume your VCR is connected to inputs as shown on this page. If you use any other inputs for your VCR or add a second VCR, this change must match in the NetCommand system. See Edit NetCommand... in Chapter 3 for more information.

Figure 5. Connecting a VCR to an Antenna or Wall Outlet Cable

Connecting a VCR to a Cable Box (Audio & Video)

VCR to a Cable Box (Audio & Video)

Figure 6

A two-way RF splitter, 4 coaxial cables, right and left audio cables and an S-Video or Video cable are required. These are not included with the TV but are available at most electronics stores.

1. Connect the incoming cable to IN on the RF splitter.
2. Connect one coaxial cable from OUT on the RF splitter to ANTENNA IN on the cable box back panel.
3. Connect one coaxial cable from OUT on the RF splitter to ANT-1 MAIN on the TV back panel. This connection also allows you to use the TV Guide On Screen® feature.
4. Connect one coaxial cable from OUT on the cable box to ANTENNA IN on the VCR back panel.
5. Connect one coaxial cable from ANTENNA OUT on the VCR back panel to ANT-2 AUX on the TV back panel (optional).
6. To use the TV speakers with the VCR, connect a set of audio cables from AUDIO OUT on the VCR back panel to INPUT-1 AUDIO-LEFT (MONO) and AUDIO-RIGHT on the TV back panel. The red cable connects to the R (right) channel and the white cable

connects to the L (left) channel. If your VCR is mono (non-stereo), connect only the white (left) cable.

7. Connect either an S-Video or composite video cable from VIDEO OUT on the VCR back panel to INPUT 1 VIDEO on the TV back panel. Connect only one type of video cable. S-Video is recommended, if available.
8. For NetCommand®-controlled recordings (including TV Guide On Screen)
 - a. Connect a set of audio cables from AUDIO IN on the VCR back panel to RECORD OUTPUT/AUDIO-LEFT (MONO) and AUDIO-RIGHT on the TV back panel. The red cable connects to the R (right) channel and the white cable connects to the L (left) channel.
 - b. Connect a video cable from VIDEO IN on the VCR back panel to RECORD OUTPUT/VIDEO on the TV back panel.

Note: With this connection configuration, it is possible to view live cable programs through the VCR. For best picture quality, however, always view live cable programs directly from the cable box instead of the VCR.

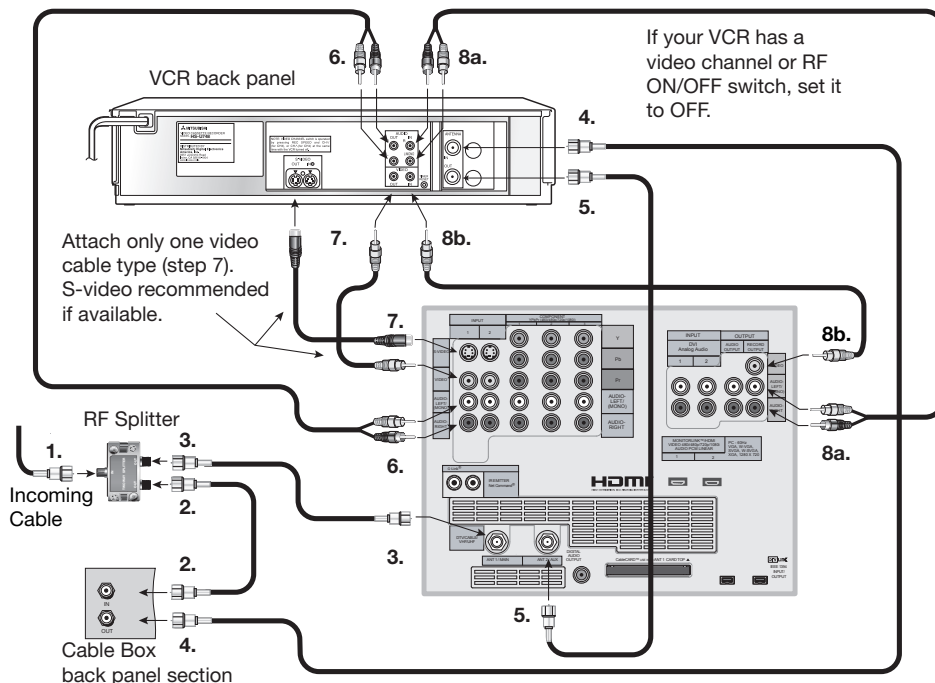

Note: NetCommand® will assume your VCR is connected to inputs as shown on this page. If you use any other inputs for your VCR or add a second VCR, this change must match in the NetCommand system. See Edit NetCommand... in Chapter 3 for more information.

Figure 6. Connecting a VCR to a Cable Box

Connecting an A/V Receiver (Stereo System) Connecting a Satellite Receiver or Other Device with S-Video

A/V Receiver (Stereo System)

Figure 7

Most setups require either a digital audio cable or stereo audio cables. In some circumstances, you may need to connect both digital audio and stereo audio. A digital audio cable is provided with the TV. Stereo audio cables are not included.

A. To connect an analog A/V receiver:

Connect a set of stereo audio cables from AUDIO OUTPUT on the TV back panel to the TV AUDIO INPUT on the back of the A/V receiver. The red cable connects to the R (right) channel and the white cable connects to the L (left) channel.

B. To connect a digital A/V receiver with Dolby® Digital surround sound:

Connect one end of the digital audio cable supplied with the TV to DIGITAL AUDIO on the back of the TV. Connect the other end to the COAXIAL DIGITAL INPUT on the back of the A/V receiver.

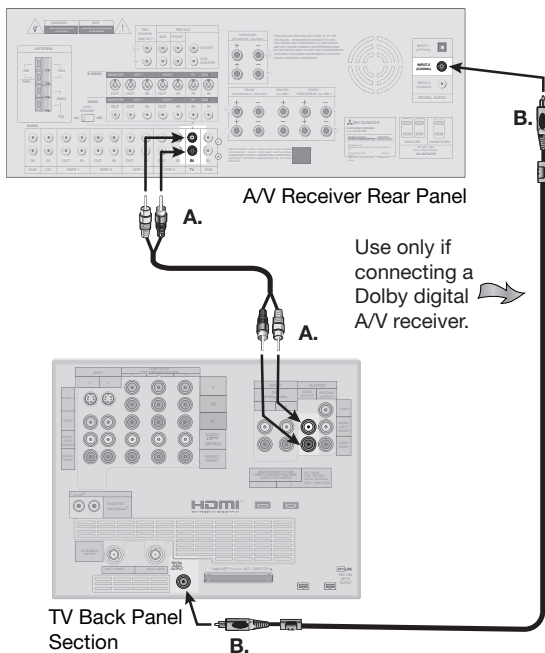

Figure 7. Connecting an A/V receiver

On rare occasions, an HDMI signal may be copy-restricted and cannot be output from the TV as a digital signal. To hear these copy-protected signals through the A/V receiver, use connections for analog A/V receivers.

MP3 audio from memory cards cannot be output as digital audio. To listen to MP3 playback from the TV memory card player through your A/V receiver, use the connections for an analog A/V receiver

Check the A/V receiver's Owner's Guide for information concerning use of the digital input and switching between digital sound and analog stereo sound from the TV.

Satellite Receiver or Other Device with S-Video

Figure 8

An S-Video cable and audio cables are required. These are not included with the TV.

1. Connect an S-Video cable from VIDEO OUT on the satellite receiver back panel to INPUT-2 S-VIDEO on the TV back panel.
2. Connect a set of audio cables from AUDIO OUT on the satellite receiver back panel to INPUT-2 AUDIO on the TV back panel. The red cable connects to the R (right) channel and the white cable connects to the L (left) channel.

Note: Refer to the Satellite Receiver Owner's Guide for Dish Antenna connections

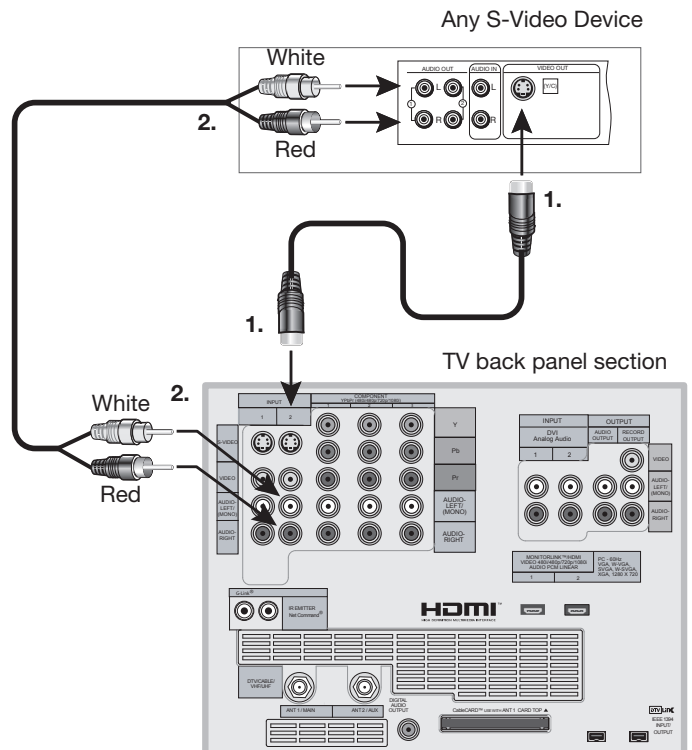

Figure 8. Connecting a Satellite Receiver with S-Video

Note: NetCommand® assumes you connected your satellite receiver to Input-2. If you add a second satellite receiver or use any other inputs for your satellite receiver, this change must match in the NetCommand system. See *Editing NetCommand Setup* in Chapter 3 for more information.

Connecting a DVD Player with Component Video

Connecting a DVI Device

DVD Player with Component Video

Figure 9

Component video cables and audio cables are required. These are not included with the TV.

1. Connect the Component Video cables from Y/Pr/Pb VIDEO OUT on the back of the DVD player to COMPONENT-2 on the TV back panel, matching the correct connection:
 - Y to Y (Green)
 - Pr to Pr (Red)
 - Pb to Pb (Blue)
2. Connect a set of audio cables from AUDIO OUT on the back of the DVD player to COMPONENT-2 AUDIO Input on the TV back panel. The red cable connects to the R (right) channel, and the white cable connects to the L (left) channel.

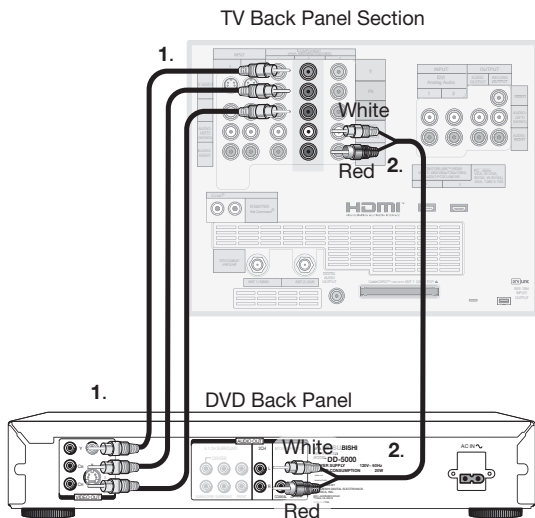

Figure 9. Connecting a DVD Player with Component Video

Note: NetCommand® assumes you connected your DVD player to Component-2. If you add a second DVD or use any other inputs for your DVD, this change must be reflected in the NetCommand system. See *Edit NetCommand...* in Chapter 3 for more information.

DVI Device

Figure 10

A DVI-to-HDMI cable or DVI/HDMI adaptor and HDMI cable and audio cables are required. These are not included with the TV. They may be available at your local electronics retailer.

1. Connect the DVI-to-HDMI cable (recommended) or HDMI cable with DVI/HDMI adaptor from the DVI device's back panel to the TV back panel.
- NOTE:** If you are using a DVI/HDMI adaptor, it is important to connect the adaptor to the DVI device for best performance.
2. Connect a set of audio cables from AUDIO OUT on the DVI device back panel to the INPUT/DVI Analog Audio on the TV back panel. The red cable connects to the R (right) channel, and the white cable connects to the L (left) channel.

NOTE: The HDMI connection supports copy protection (HDCP). Some devices require connecting to an analog input first, in order to view on-screen menus and select DVI as the output. Please review your equipment instructions for DVI connectivity and compatibility.

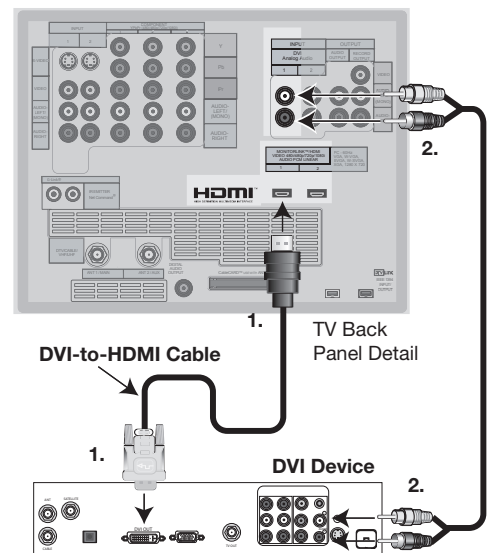

Figure 10. Connecting a DVI Device

IMPORTANT

See Appendix A for component video signal compatibility information.

For digital audio connections to your A/V receiver, see your DVD player and A/V receiver Owner's Guides.

Connecting an HDTV Cable Box or Satellite Receiver with Component Video

Connecting an HDMI Device

HDTV Cable Box or Satellite Receiver with Component Video

Figure 11

A coaxial splitter, RCA component video cables, and audio cables are required. These are not included with the TV.

1. Connect the outside antenna, cable, or satellite to ANT or SATELLITE IN on the cable box or satellite receiver. See your device's owner's guide for instructions and cable compatibility.
2. Connect the incoming terrestrial antenna or cable (not satellite) to ANT-1 on the TV back panel (a coaxial splitter, available at most electronic supply stores, may be required to complete this installation).

HDTV Receiver to TV Back panel

- Y to Y
- Pr to Pr
- Pb to Pb

4. Connect L (left) and R (right) audio cables from the DTV receiver to Component-1 AUDIO on the TV back panel.
5. If you are using a satellite receiver, you must change the input through NetCommand. Open the NetCommand Connection for [Device] screen (see page 50) to make the change.

Note: To receive the benefits of a digital A/V receiver, connect your cable box or satellite receiver's digital audio out to a digital input on your digital A/V receiver.

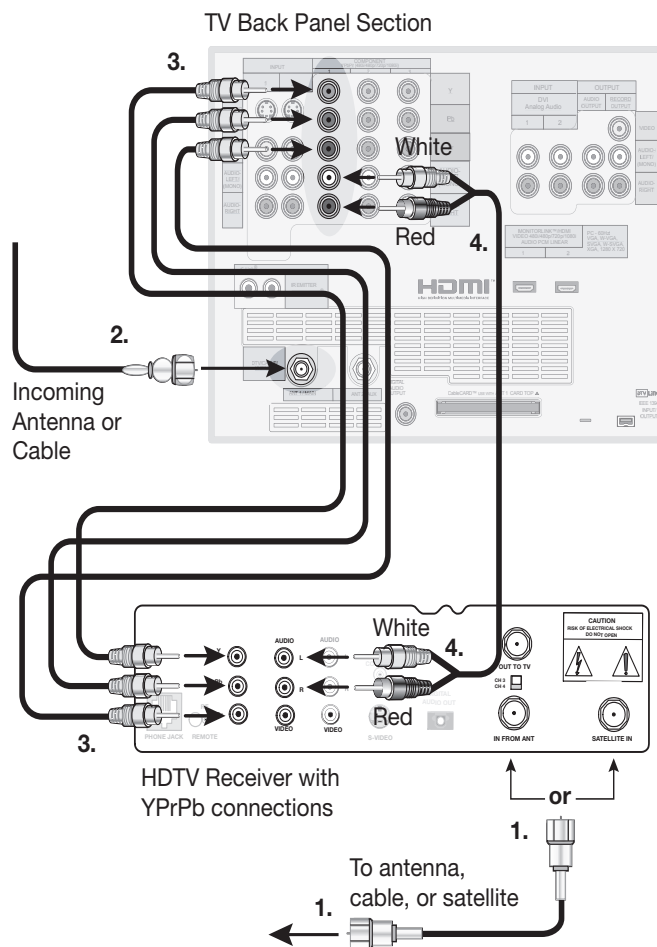

Figure 11. Connecting an External HDTV Receiver with Component Video Connections

3. Connect RCA-type cables from the YPrPb outputs on the HDTV receiver to Component-1 on the TV back panel, matching the correct connections:

HDMI Device

Figure 12

An HDMI-to-HDMI cable is required. This is not included with the TV. It may be available at your local electronics retailer

Connect an HDMI cable from the TV back panel to the HDMI device output. HDMI devices provide video and audio through this cable, so no other connection is required. You can connect two HDMI devices to the TV back panel through the HDMI connections.

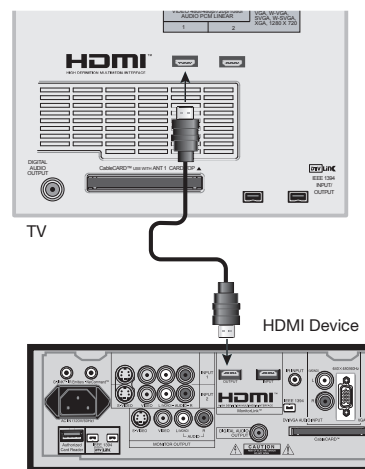

Figure 12. Connecting an HDMI Device

Note: To use the benefits of digital surround sound from the HDMI device, connect the digital audio output of the HDMI device directly to the A/V receiver.

Connecting a Computer with an HDMI or DVI Monitor Output

Computer with an HDMI Monitor Output

Figure 13

An HDMI-to-HDMI cable is required. This is not included with the TV. It may be available at your local electronics retailer

Connect an HDMI cable from HDMI 2 on the TV back panel to the PC's HDMI output. HDMI devices provide video and audio through this cable, so no other connection is required.

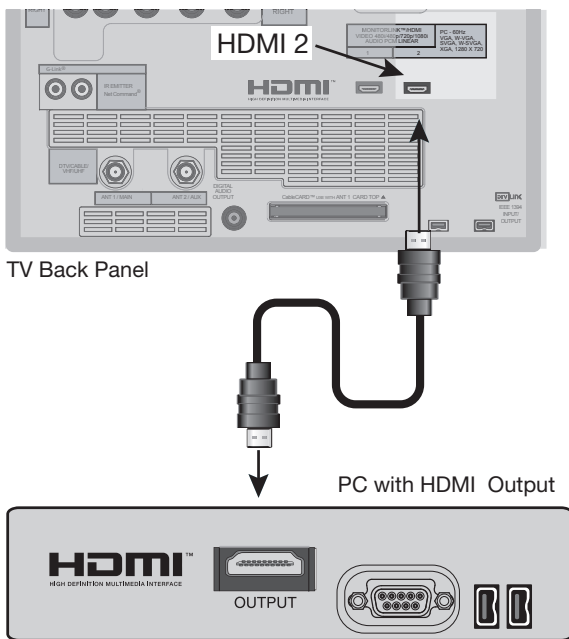

Figure 13. Connecting a Computer with an HDMI Monitor Output

IMPORTANT

To view PC video on the TV:

- Activate the PC option in NetCommand. You can do this during initial NetCommand setup (in the Device Setup screen), or at any time afterwards by using the NetCommand Add function.
- See Appendix A for signal compatibility.



CAUTION: To ensure continued FCC compliance, the user must use a shielded video interface or HDMI cable with bonded ferrite cores at both ends when using the PC input.

Computer with a DVI Monitor Output

Figure 14

A DVI-to-HDMI cable or DVI/HDMI adaptor and HDMI cable and audio cables are required. These are not included with the TV. They may be available at your local electronics retailer.

1. Connect the DVI-to-HDMI cable (recommended) (or DVI/HDMI adaptor with an HDMI cable) from the PC DVI output to HDMI 2 on the TV back panel.

NOTE: If you are using a DVI/HDMI adaptor, it is important to connect the adaptor to the DVI device for best performance.

2. Connect a set of audio cables from AUDIO OUT on the PC back panel to INPUT/DVI Analog Audio 2 on the TV back panel. The red cable connects to the R (right) channel, and the white cable connects to the L (left) channel.

NOTE: The HDMI connection supports copy protection (HDCP). Some devices require connecting to an analog input first, in order to view on-screen menus and select DVI as the output. Please review your equipment instructions for DVI connectivity and compatibility.

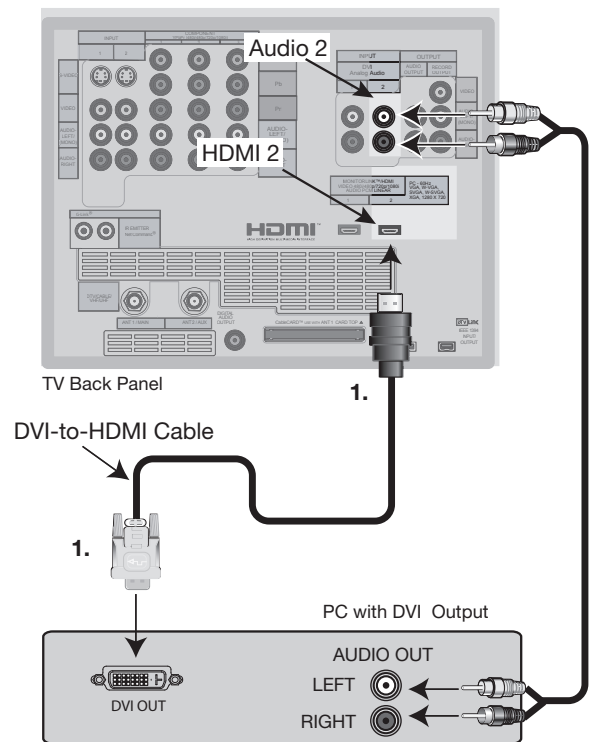

Figure 14. Connecting a Computer with DVI Monitor Output

Connecting the IR Emitter NetCommand®

IR Emitter NetCommand®

Figure 15

An IR emitter cable is included with the TV.

The emitters connected to these jacks are used by the NetCommand system and by TV Guide On Screen® to control other devices such as VCRs, DVD players, Cable boxes and Satellite receivers.

1. Connect the plug end of the supplied IR Emitter Cable to either one of the IR Output NetCommand jacks on the TV back panel.
2. Run the cable for each of the emitter ends under, alongside, or over the top of each device to be controlled to the area of the front where the remote control sensor is located.
3. Place the emitter end in front of the remote control sensor of the device to be controlled. The emitter bulb should face the remote control sensor. This bulb emits infrared light in a cone shaped pattern. The bulb needs to be placed far enough from the remote control sensor to allow the cone pattern to include the sensor.

The remote control sensor is usually behind the plastic window of the front display panel. It is sometimes visible when you look through the display plastic using a flashlight and is normally a round or square cutout behind the plastic. If you cannot see the sensor and the device's Owner's Guide does not specify the location, you can find it by using the device's remote control.

- a. Hold the remote about one-half inch from the front of the device. Starting from one end of the display window plastic, press the POWER button.
- b. If the device does not respond, move the remote control one inch toward the center and try again.
- c. Repeat this until the device responds.
- d. Note this location and then start over from the other end of the display window plastic, repeating until the device responds again.

The remote control sensor will be somewhere between these two positions. This is usually enough accuracy for the placement of the IR emitters.

- With some devices, the emitter works better facing downward from the top of the device. Some experimentation may be needed.

- The emitter end being used can be secured in place using double stick tape.
- If you are not going to be using all emitter ends, place the unused ends behind the devices so that they cannot send signals to the remote control sensors.

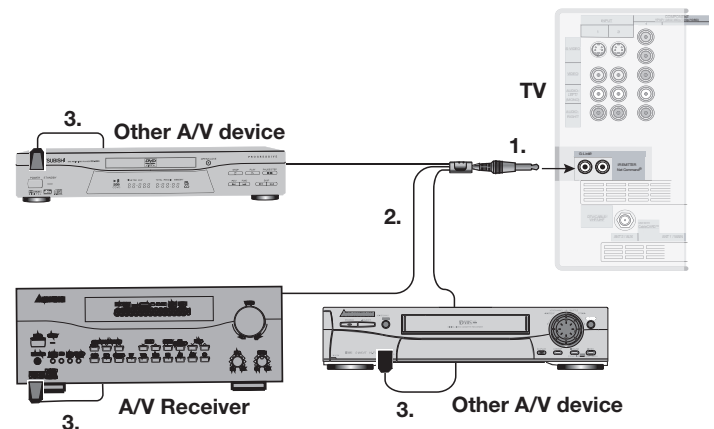

Figure 15. Connecting IR Emitter NetCommand

IMPORTANT

If a single emitter end can be placed in a position that will operate more than one device, do not use a separate emitter end for the additional device. A single device receiving remote control signals from too many emitters or remote controls may not respond at all.

Connecting Compatible IEEE 1394 Devices

Compatible IEEE 1394 Devices

Compatible A/V devices include some, but not all, cable boxes, D-VHS VCRs, A/V discs, and future products. It is also possible to connect devices to the TV that have IEEE 1394 connectors but are not compatible with the TV or with the NetCommand® control system. Areas of compatibility to consider are:

1. Digital Video Signals

The TV is able to decode MPEG2 and DV video as provided by some camcorders. If the TV is unable to decode the digital signal supplied by your camcorder, try S-video with analog audio connections instead. Other types of digital video, such as PC video provided by some computers, must be decoded by the source device and sent to the TV as analog video, S-video, or HDMI video.

2. Digital Audio Signals

When received with video signals, the TV is able to decode Dolby Digital signals and MPEG audio signals. Other types of digital audio as provided by some digital recording devices, such as MP3 audio and DTS audio, cannot be decoded by the TV when received over IEEE 1394

The TV may not be able to pass incompatible digital audio signals on the coaxial digital audio output, however, these signals may pass on the IEEE 1394 cable to other devices.

3. Digital Control Signal

The TV can serve as the control center for IEEE 1394 audio/video devices, such as VCRs, A/V Discs, tuners, cable boxes and amplifiers that are compatible with the following IEEE 1394 control standards.

- **EIA-775** is designed for tuning devices such as cable boxes, allowing the device to send simple graphics. This standard does not, however, allow the TV to control the cable box by IEEE 1394.
- **AV/C (Audio Video Control)** is designed to provide basic controls such as play, stop, channel selection, and volume, as appropriate for the device.

The IEEE 1394 interface may not provide reliable control signals for some DV camcorders, especially older models. If your camcorder operates incorrectly or not at all, use the camcorder's control buttons instead of the IEEE 1394 connection.

Some devices may be a combination of two or more types of devices. For example, there may be a recording device that is also a tuning device. Each portion of the device is called a sub-unit. When you select a device on the Device Selection menu that has sub-units, a pop-up menu will appear so you can select which sub-unit section you wish to use.

When Connecting IEEE 1394 Devices

- Do not loop the last device in the chain back to the TV. When the device chain is looped, the TV may not be able to work with the other devices.

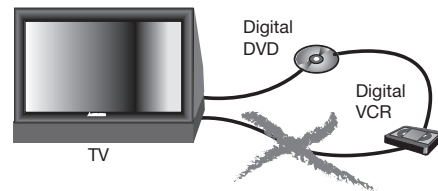

- Place devices that have only a mechanical (two-position) power switch at the end of the chain or leave the power switch in the On position. When turned Off, IEEE 1394 signals may not be able to pass through the device to other devices.
- Place devices with the slowest communication speed at the end of the chain. Sometimes the communication speed will be marked near the IEEE 1394 connector with an “S” number. The higher the number, the faster the communication speed. This TV has a communication speed of S400. Devices with slow communication speed can interfere with IEEE 1394 signals from faster devices. When using NetCommand to set up a digital recording between a faster device and a slower device, make the slower device the source and make the faster device the recorder.
- Do not use an IEEE 1394 cable over 15 feet in length between each device.
- This TV is an IEEE 1394a device. It can be used with a 1394b system when an IEEE-1394a-to-1394b convertor is used. 1394b systems are capable of greater distances and multi-room applications.

IMPORTANT

DV Camcorder Playback

- A. When viewing DV camcorders, it is normal for temporary audio and video distortion to occur under conditions such as:**
- Playback start and stop
 - Playback pause
 - Forward or reverse picture search
- B. Some DV Camcorder models are not compatible with this TV's IEEE 1394 system. Because of this, the “New 1394 Device” screen will not appear when the camcorder is connected. For playback of incompatible DV camcorders, try S-video with analog audio connections instead.**

Connecting Compatible IEEE 1394 Devices, continued

Connection Styles

There are two different connection styles that can be used when connecting IEEE 1394 devices. Use the style that fits your network of audio/video products.

Direct Device-To-Device Style

The IEEE 1394 offers you the capability to chain devices, unlike previous audio and video connections where you had to individually connect each device directly to the TV. For example, you can connect your D-VHS to your 1394 DVD Player and then connect the 1394 DVD Player to the TV. The resulting IEEE 1394 chain will allow you to add more devices to the chain. You will be able to see each video device on the TV's Device Selection Menu and send information from any IEEE 1394 device to other compatible devices.

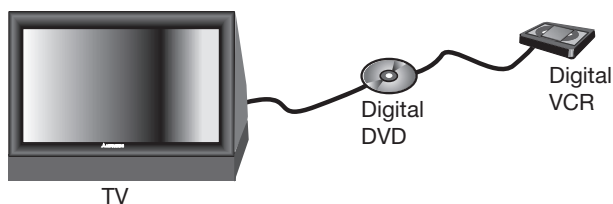

Hub Connection Style

The IEEE 1394 also offers you the capability to connect your devices using the TV as a hub within the audio/video network. Each device can send information, which may include audio and video, to any other device in the network.

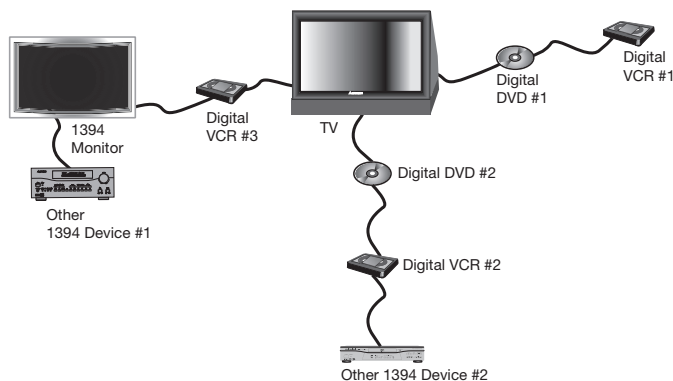

4-Pin-Style vs. 6-Pin-Style Connectors

There are two different types of connectors used for IEEE 1394 terminals and cables: a 4-pin and a 6-pin style.



4 pin connector

The 4-pin connector sends digital audio signals, digital video signals, and digital control signals back and forth between devices. Your TV has three 4-pin-type connection jacks available. One is on the front panel and two are on the back.



6 pin connector

The 6-pin connector can send the same digital audio, video, and control signals as the 4-pin connector, but the 6-pin connector can also send low-voltage electrical power. This TV does not have 6-pin connectors.

The purpose of this low-voltage electrical power is to provide the needed operating power to a device that is not connected directly to the household AC power, such as a camcorder. A device with a 6-pin connector can send this electrical power to another device, or receive electrical power from another device, or simply use a 6-pin connector without using the two additional pins.



6 pin to 4 pin adaptor

A 6-pin connector cannot be connected directly to a 4-pin jack, and vice versa. To connect a 6-pin device to a 4-pin device, you need to obtain a 6-pin-to-4-pin adaptor or adaptor cable. These cables are available from electronic and computer stores.

When connecting a 6-pin device (such as a camcorder) to the TV, (if it is designed to receive electrical power from another 6-pin device) you will need to connect the camcorder directly to the household AC, or use the camcorder's battery for power. If this is not possible, then the camcorder will need to be connected directly to another 6-pin device in the network that can provide the electrical power.

Helpful Hints for NetCommand Connections

Q. My VCR (or other device) does not have two sets of stereo audio outputs. How can I connect this device's audio to both the TV and the A/V Receiver?

A. Connect the single set of stereo audio outputs to the TV only. Use Edit NetCommand® to change the setup of this device. In the Connection screen of "Change" make sure both audio and video for the TV input are check marked and the audio for the AVR input is not check marked. This will allow the NetCommand system to use the TV outputs to transfer the device's audio to the A/V Receiver. See Edit NetCommand in the next chapter for details.

Q. I have both the TV stereo audio output and TV digital audio output connected to the same input designations on my A/V Receiver. How do I switch between analog audio and digital audio?

A. In most setups, analog audio is also output as digital audio, so no switching is required, and there is no need to connect the analog output. In some circumstances, however, you may also need analog audio from the TV. For example, MP3 audio is only output in analog format, so you must connect the TV's analog AUDIO OUTPUT to the A/V Receiver if you want to hear MP3 audio through the A/V receiver. Refer to your A/V Receiver user's guide to find out how analog/digital audio switching works.

- If your A/V Receiver's remote control has an Analog/Digital Audio key, you can use the GUIDE key with the following models to control switching:

Mitsubishi M-VR900	Integra DTR-9.1
Denon AVR-2700	Kenwood VR-2080

To make the switch, press the Device key on the TV's remote control, and from the Device Selection menu, press the Audio key. Then, with the A/V Receiver highlighted, press the GUIDE key to make the switch.

- If you have some other A/V Receiver model, use the TV's learn function to learn the analog/digital audio code for the GUIDE key. Follow the instructions above for using the GUIDE key.
- If your A/V Receiver has an Analog/Digital selection key on the front panel only, and not on the remote, then your only option is to use that key to perform switching.

Q. The front panel of my A/V Receiver is too tall or too convex for the IR emitter signal to reach the remote control sensor of the A/V Receiver. What can I do?

A. There are several possible solutions.

1. Mount the IR Emitter on the top, front edge of the A/V Receiver over the remote control sensor. Use tape to secure it in place.
2. Mount the IR Emitter on the underside of the shelf above the A/V Receiver (if the A/V Receiver is in a cabinet). Use double sided tape to secure it in place.
3. Some small stick-on emitters from other manufacturers may be compatible with this TV's IR Emitter jacks. These may be used instead of the supplied IR Emitters.

Q. I occasionally need to see the menu from my A/V Receiver. How can I connect it to the TV for this purpose?

A. You can connect the video output of the A/V Receiver to an unused input on the TV. Then use Edit NetCommand to "Add" this as an "Other" device, not an A/V Receiver. On the "Connection" screen, indicate which TV input was used and check mark the video box. Make sure the TV input audio box and both the audio and video boxes for the AVR input are not check marked. You should also name this device so you can easily identify it on the Device Selection Menu. You can also use Input 3 on the front panel.

Q. I have a high definition receiver I would like to connect and it also has an S-video output I would like to be able use as well. Is there any way to connect this receiver both ways?

A. Yes, this item will appear twice in the Device Selection Menu. Just add this unit once using the Component-1 and once using one of the S-video inputs. Make sure you indicate that this is the same manufacturer for both. We suggest that you connect stereo audio outputs with the S-video to the TV so that you do not need to use two inputs on the A/V Receiver. If this is a NetCommand compatible HDTV receiver and HD or SD outputs can be switched by remote control, see *Edit NetCommand* in the next chapter for NetCommand control of this feature.

NetCommand® Setup and Editing

NetCommand® Introduction	38
Using the Remote Control with NetCommand®	39
NetCommand® Setup On-Screen Buttons.	40
3D Graphical ▶ViewPoint® Menu System	41
NetCommand® Initial Setup	42
Edit NetCommand®: Add an A/V Receiver	45
Edit NetCommand®: Add Devices	48
Edit NetCommand®: Change or Delete Devices	52
IEEE 1394 Devices and NetCommand® Control	53
Adding IEEE 1394 Devices Automatically.	54

NetCommand® Introduction

NetCommand makes your TV the heart of your Home Theater

NetCommand® is an intelligent control system that makes your Mitsubishi TV the heart of your home theater. With NetCommand, the TV sends signals to the other devices in the system via the IR emitters, telling the devices to play, record, change inputs, adjust volume, change channels and many more functions. All of this is accomplished with one remote control and without changing control layers.

IR Learning and IEEE 1394 Support

The IR “Learning” feature of NetCommand allows the TV to learn the remote control signals for new devices that the TV is not preprogrammed to operate. NetCommand® also includes the capability of controlling IEEE 1394 devices by sending control signals on a FireWire® cable.



Using NetCommand is completely optional

When you first turn on the TV, the NetCommand Setup Wizard launches. If you decide to use NetCommand, follow the on-screen instructions. If you choose not to use it right away, simply quit the Setup Wizard and NetCommand will remain inactive. Later, if you decide to use NetCommand, you can easily access the Setup Wizard.

NetCommand and Levels of Control

When you set up NetCommand, you decide how much control you want the TV to have over your home theater system. You have the choice of performing a basic, limited, or complete NetCommand setup.

• **Basic Setup**

In a basic setup, NetCommand will:

- ◇ automatically switch to the correct TV input when you want to view programming from a different device. All you do is select the device from the on-screen device selection menu. This saves you from having to search for the correct input every time you want to change devices. Unused inputs are automatically deactivated so that you don't see them in the menu.
- ◇ show an on-screen icon for each device connected to the TV so you always know what devices are available.

Note that with a basic setup, you still need to use the remote control specific to each device.

• **Limited Setup**

In a limited setup, you get the benefits of the basic setup plus NetCommand control over the specific devices you have chosen. Use this type of setup if you:

- ◇ only want NetCommand to control a few devices, such as the TV, a playback device (like a DVD player), and a cable box. With this setup, you can use the TV's remote to control these devices.
- ◇ want to use TV Guide On Screen® to control your cable box and VCR and/or A/V disc. After performing this setup, you can use the TV's remote to control these devices.

• **Full Setup**

Perform a full setup if you want NetCommand to:

- ◇ control a surround sound A/V receiver.
- ◇ automatically change input selections for the A/V receiver.
- ◇ control all devices with the TV's remote, including the A/V receiver.

NetCommand Helps You Manage Your Home Theater

With the NetCommand Review screen you can:

- view a summary of all devices connected to the TV and the input used for each device.
- deactivate or turn off unused input connections; reactivate or turn them on.

If you need to change your setup, the NetCommand sub-menu lets you easily

- add new devices.
- deleted devices you have disconnected.
- change device and input selections.

Using the Remote Control with NetCommand®

Below is a list of several manufacturers' devices tested and shown to be compatible with NetCommand. These devices can be controlled without changing the setting of the remote control from TV to another product. NetCommand may be able to operate additional models, since many manufacturers use the same control signals to operate some or all of the models they offer. This chart lists only the models that have been tested with NetCommand. The NetCommand Learning feature is able to learn the remote control signals of most audio/video devices. For devices not listed in the table, or if your device does not operate using the same remote control as the models listed below, use the learning feature by selecting "Other" at the [Device] screen. See the *Edit NetCommand* section of this Guide.

NOTE: There are many different types of remotes and not all of them may be compatible with the learning feature. Bright light near the TV screen can also adversely affect the learning feature. If it is not possible to learn a device, you will need to use the original remote control of the device, or program the TV remote to operate these devices in the traditional manner.

NetCommand Pre-Memorized Devices

	DEVICE					
		A/V receiver	Cable Box	SAT Satellite Receiver	DVD Player	VCR
M A N U F A C T U R E R	Mitsubishi	M-VR800, M-VR900		SR-HD5	DD-6000, DD-8020	HS-U795, HS-U778
	Bose	Lifestyle® 28			Lifestyle® 28	
	Denon	AVR-2700				
	Echostar			6000		
	Funai					F260LA
	General Instruments		CFT2200			
	Hitachi				DV-P415U	VT-FX665A
	Hughes			HIRD-E45, HIRD-E86		
	Integra	DTR-9.1			DPS-9.1	
	Jerrold		Not specified			
	JVC				XV-S65GD	HR-VP 650U
	Kenwood	VR2080				
	Marantz	SR8200				
	Microsoft				XBox™ (requires the DVD kit from Microsoft)	
	Motorola		DCT2244			
	Panasonic			TU-HDS20	DVD-A310	PV-8662
	Philips					VR620CAT
	Pioneer	VSX-D557, VSX-49TX			DV-414	
	RCA			DRD480RE, DTC-100		
	Rotel	RSX-1065				
Scientific Atlanta		8600				
Sharp					VC-H810U	
Sony	STR-DE825		SAT-A55	DVP-S500D, PlayStation® 2 (Playstation® 2 requires the DVD Remote Controller kit from Sony; DVD Player software disc version 2.10)	SLV-778HF	
Toshiba			DTS-3000	SD-9200, SD-5109	W-717	
Yamaha	RX-V2095, RX-V2200			DVD-S520, DVD-C996		
Zenith			DTV1080			

NetCommand® Setup On-Screen Buttons

To use the TV's NetCommand feature, you need to provide some detailed information during the setup of your Mitsubishi TV. You must define the manufacturer of the devices that are connected to the television, or learn the IR code remote control signals for the device connected. For each device, the input to the TV and A/V receiver, and the names for the device are pre-set during Initial NetCommand setup. You may change those inputs or names using the Edit NetCommand or Learn screens. The buttons described below will help you navigate the screens.

On your remote control, the ADJUST ◀ or ▶ buttons allow you to navigate left and right to different selections on the screen. The ADJUST ▲ or ▼ buttons allow you to:

- Change the radio button
- Change current text box selection
- Navigate up and down on the screen

The ENTER button allows you to:

- Confirm the selected character when naming a device
- Add or delete check marks in check boxes
- Select on-screen buttons to change screens

Text Box

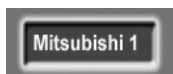

Press ADJUST ▲ or ▼ to make a selection.

Check Box



Check marks indicate the item or input is added or turned On. Press ENTER when the check box is highlighted to add or delete a check mark. When viewing the Review screen, a check box reflects which devices are turned On or Off, or connected to the TV.

Radio Buttons



The setting changes when one of the choices is highlighted.

Control Buttons

Much like the software on your computer, you will use graphic buttons to navigate through the NetCommand Setup screen. Highlight the button and press ENTER to select the function.

<Back Button



Use the <Back button to navigate back to the previous screen.

Next> Button



Use the Next> button to navigate forward to the next screen.

Cancel Button



The Cancel button will cancel out any changes you are currently making without saving them into memory. When you select the Cancel key, NetCommand will prompt you to confirm that you want to cancel the changes you are currently making. If you select Cancel during Initial Setup, you can set up NetCommand later by selecting the NetCommand menu, then choosing Initial.

3D Graphical ▶ViewPoint® Menu System

Your TV also has Mitsubishi's exclusive 3D Graphical on-screen operating system, which provides on-screen information for menu choices and changes, using the TV's remote control.

▶ViewPoint® Menu Screens



A picture (icon) is highlighted on the menu screen when selected with the ADJUST arrows. You may then make changes within the menu or access sub-menus, if available.



You can also access sub-menus from a button. Sometimes when you select a button, an automatic function begins.

The ▶ViewPoint® system includes the following special features:

- The currently selected icon or button is highlighted with a yellow outline; the text color is yellow.
- On-screen instructions, shown in the message line at the bottom of the menu, provide feature selection and adjustment information.
- Some on-screen menu options must be set before other options are available.



Main Menu: This screen is always the first to appear when you press the remote's TV MENU button.

▶ViewPoint® Remote Control Buttons

The following buttons on your remote control help you navigate within the ▶ViewPoint® system:

1. ADJUST ◀ or ▶ to select the menu item you want to change.
2. ADJUST ▲ or ▼ to change the settings.
3. ENTER to open a menu, start an automatic function, or select a check box.
4. TV MENU to display the main menu or move back one menu screen at a time.
5. CANCEL to clear a setting or stop an automatic function.
6. HOME to exit all menus and return to TV viewing.

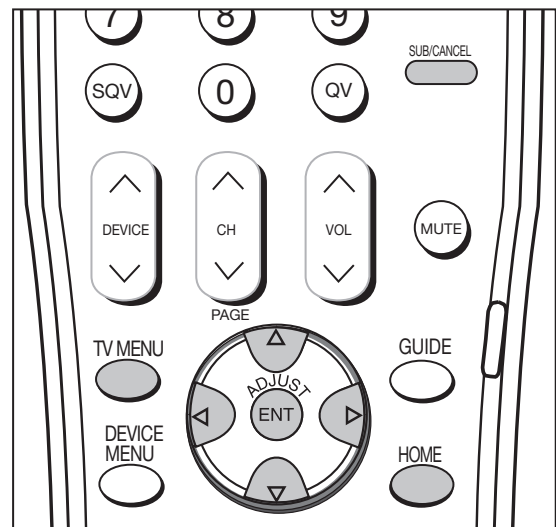

Press ADJUST ▲ or ▼ to change text boxes. Some text boxes have preset labels. Other boxes allow you to select letters, numbers or characters to customize names.

NetCommand® Initial Setup

The initial setup screens that appear when you first power on your new Mitsubishi TV guide you through setup of NetCommand and the TV Guide On Screen® system. Most IR remote control signal formats can be learned by NetCommand.

Welcome Screen

Figure 1

When you first turn on your TV, the NetCommand Welcome screen displays and asks you to select either English or Spanish as the language for the on-screen menus. The default language is English. To change Language later, select Setup in the Main Menu. Selecting **Cancel** at this screen will cause the default language (English) to be selected.



Figure 1. Welcome screen

NetCommand (Information) Screen

Figure 2

The NetCommand (Information) Screen describes how to start or delay the initial NetCommand and TV Guide On Screen setup. This screen displays automatically the first time you power On your new TV, after the Welcome screen.

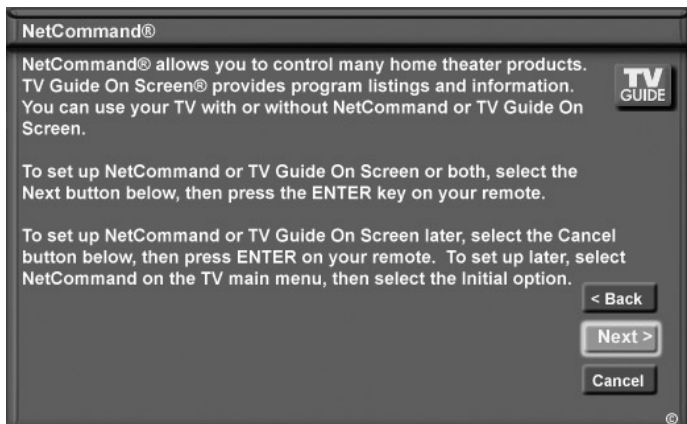

Figure 2. Information screen

Select **Next>** and press ENTER to start the initial setup.

If the NetCommand Setup is cancelled before it's completed, you can restart the NetCommand setup from the Setup Reminder screen (see below) or by doing the following:

1. Press TV MENU on the remote control to display the TV Main menu.
2. Select NetCommand. The available options will be Add, Review, Guide or Initial. Change and Delete will be grayed out.
3. Press ADJUST ▲▼◀▶ to select Initial.
4. Press ENTER. The Device Setup screen (shown on the next page) displays.

Setup Reminder

Figure 3

This screen only appears if you did not set up NetCommand when the TV was first turned on. The Setup Reminder screen displays for the next six times you power on the TV.

If you would like to set up NetCommand and/or the TV Guide On Screen system, select Next and press ENTER. If you do not wish to set up NetCommand and/or the TV Guide On Screen system, then select Cancel and press ENTER.

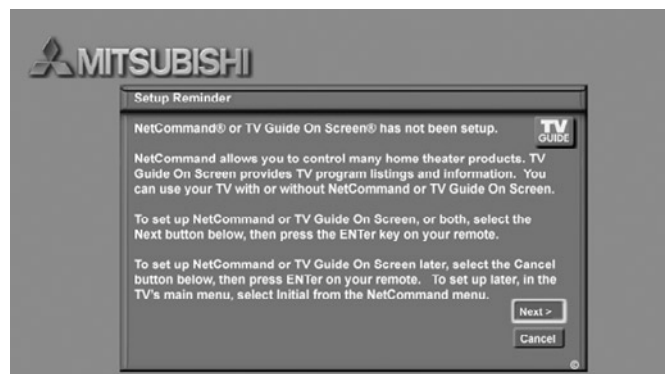

Figure 3. Setup Reminder screen

IMPORTANT

You may use your TV without setting up NetCommand or the TV Guide On Screen® system. To set up at a later time, choose the NetCommand menu from the Main menu, then select Initial. The TV Guide On Screen system is set up from the NetCommand menu.

NetCommand® Initial Setup, continued

Device Setup Screen

Figure 4

If the devices connected to the TV are already in NetCommand memory, you can quickly select them at this screen. Press ADJUST ◀ or ▶ to move to each device type. Press ADJUST ▲ or ▼ to select the manufacturer. Select “Other” if the manufacturer is not listed. Later, you can use the Change setting in the Edit NetCommand menu to learn the remote control signals for this device. Select “None” for device types that are not connected.

For the A/V Receiver, if the manufacturer is not listed, you cannot select “Other”. Instead, select “None”. Later, you can use the “Add” feature in the NetCommand menu to have the TV add and learn the remote control signals for this device.

If you have a camcorder connected, check the Camcorder box. NetCommand will not be able to control it, but will reserve the front input to use with the camcorder. Check the PC box if you have a PC connected. After completing your choices, select **Next>** and press ENTER.

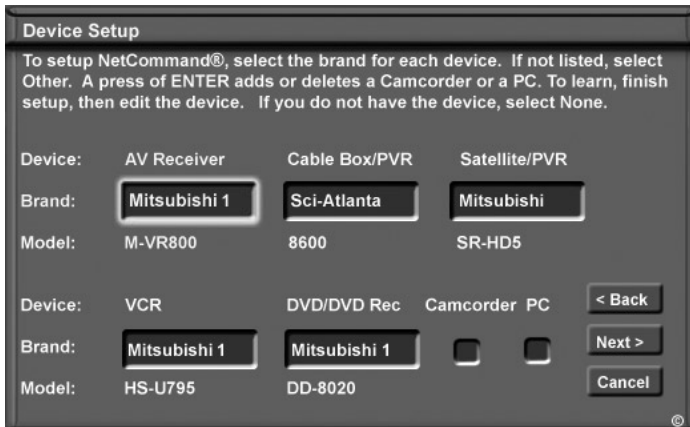

Figure 4. Device Setup screen

Note: If you selected “Other” for any of the device names, you can direct the TV to “Learn” the connected device by following the Edit NetCommand instructions. For many device types, non-listed models will operate in the same way as the listed models and you can still use the pre-loaded setting.

IMPORTANT

NetCommand must be set up and the IR emitters properly placed for your cable box and VCR so the TV Guide On Screen system can control these devices.

TV Guide On Screen® System Setup

Figure 5

The TV Guide On Screen option allows you to select whether you want to enable the TV Guide On Screen system and, if so, which devices to include. To receive the correct program listings for your area, you will need to enter your five-digit ZIP code.

You can select one over-the-air source and one cable source for TV Guide On Screen. If, however, you have multiple cable sources, the channel-number assignments may not match up correctly. See the table below for the preferred connection combinations.

If One Source Is:	The Other Source Can Be:	
	Ant-1 Air	Ant-2 Air
Cable Box	✓	✓
Cable Card	N/A	✓
Ant-1 Channels via Cable	N/A	✓
Ant-2 Channels via Cable	✓	N/A

For detailed information on using the TV Guide On Screen system, please see the separate *TV Guide On Screen Interactive Program Guide User's Manual*.

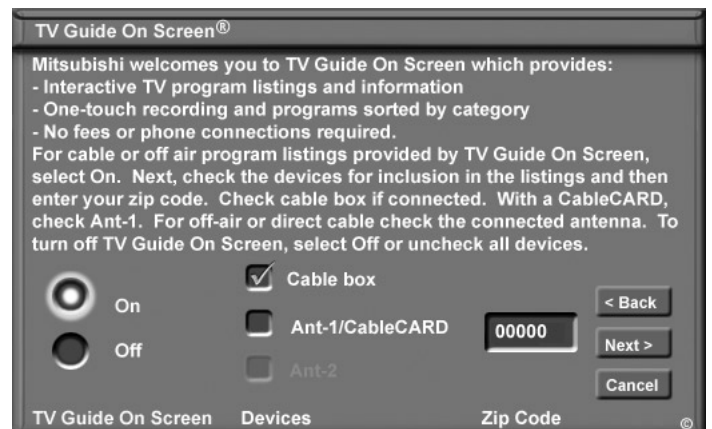

Figure 5. TV Guide On Screen

Note:

- Inputs to TV Guide On Screen can include:
 - Only one over-the-air source
 - Only one cable source
- An antenna input is required for downloading TV Guide On Screen schedules. If your cable box is connected using HDMI or IEEE-1394, you must also connect an antenna input.
- If your cable box is connected to a Component input, be sure the box is set to send analog channels as 480i. If this is not possible, add an antenna input.

NetCommand® Initial Setup, continued

Review Screen

Figure 6

After you have made your device choices, the Review Screen will display. It is important to review the settings to ensure that they are correct. If necessary, you can use **<Back** to return to the Device Setup screen to make changes.

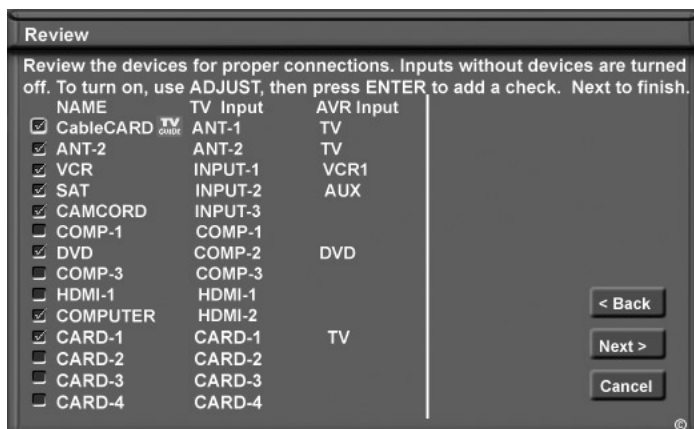

Figure 6. Review screen

Note: The Review screen lists the TV input and A/V receiver input used with each device. You must correctly identify the inputs you used when you connected the devices. If you have not connected your devices, write down these inputs as a guide. If you cannot use these inputs, or if you would like to change the name of a device, use the instructions in *Edit NetCommand* to make necessary changes.

Note: If you select **Next>** on the Review screen, all selections made are finalized.

On the Review screen, adding or deleting check marks will turn the adjacent devices or inputs On or Off. 1394 device names only appear on the Review screen when the devices are connected to the TV.

Finish Screen

Figure 7

To complete the NetCommand setup, select **Finish** from the Finish screen.

If you wish to change any of the pre-configured inputs or names for the devices, or add devices not in the pre-configured setup, select **Edit** to display Edit NetCommand menu.

If your A/V receiver was not listed, select **Edit** to add the AVR and then assign all devices to new AVR inputs.

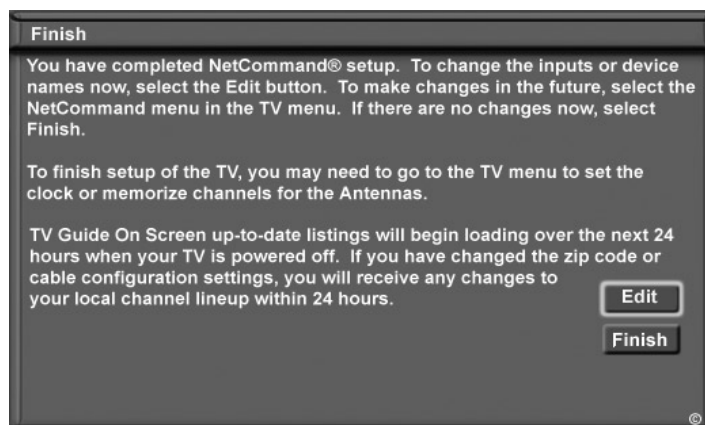

Figure 7. Finish screen

It may still be necessary to memorize the available channels for Antenna-1 (and Antenna-2, if used). You may do that by going to the TV Main menu and selecting Setup. Instructions to memorize channels are found in the *Setup* menu section.

Edit NetCommand®: Add an A/V Receiver

A/V Receiver Screen

Figure 8

If your A/V Receiver manufacturer was not listed, and you selected “None” during the initial NetCommand setup, you may add the A/V Receiver and have NetCommand learn its remote control’s functions. Either select Edit from the Finish screen or, if you have finished the initial setup, go to the Main menu, select NetCommand, then press ENTER. The Edit NetCommand screen will display. Select Add.

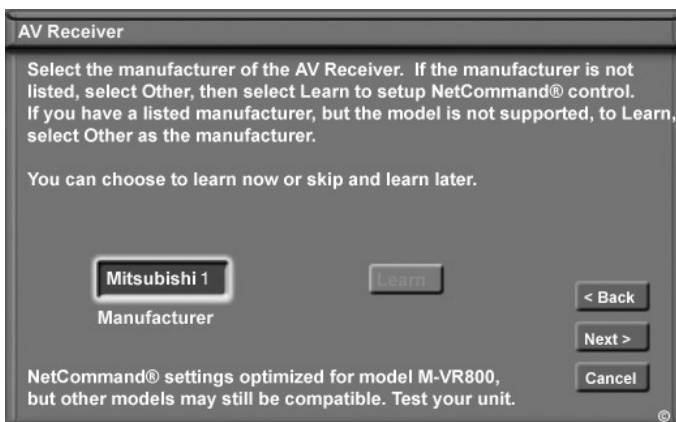

Figure 8. A/V receiver screen

Choose ONE of these options:

- Select a recognized manufacturer. The model number optimized for NetCommand will display at the bottom of the screen. If a number follows the manufacturer’s name, (example: Mitsubishi 1), this indicates additional models are optimized for that manufacturer. For many device types, non-listed models will operate in the same way as the listed models and you can still use the pre-loaded setting.

After selecting **Next>**, the screens that follow are: the Name Screen (Figure 12), Audio Output to AVR screen (Figure 13), ending with the Finish screen (Figure 14).

- Select “Other,” then highlight “Learn” and press ENTER. This will allow you to have NetCommand learn the remote control signals of this new device. After selecting “Learn” and pressing ENTER, the screens that follow are: the A/V receiver Inputs screen (Figure 9), A/V Receiver Input Learn screen (Figure 10), A/V Receiver Learn screen (Figure 11), Name screen (Figure 12), Audio Output to AVR screen (Figure 13), ending with the Finish screen (Figure 14).

- Select “Other,” skip Learn and select **Next>**. This will allow the device to appear and will allow NetCommand to switch inputs to use this device. However, NetCommand will not be able to control this device. Later you may use the “Change” option in the NetCommand menu to learn the remote control signals.

After selecting **Next>**, the screens that follow are: the A/V Receiver Input screen (Figure 9), Name screen (Figure 12), Audio Output to AVR screen (Figure 13), ending with the Finish screen (Figure 14).

A/V Receiver Inputs

Figure 9

If you select “Other” as the manufacturer and then “Learn,” you will see the A/V Receiver Input screen. After selecting the number of inputs, this screen will not appear again.

Depending on your A/V Receiver’s capability, you may connect up to seven A/V inputs. Select the number of inputs by pressing ADJUST ▲ or ▼.

If the number of connected inputs changes, you will need to delete the A/V receiver through Edit NetCommand and add it again, as described above.

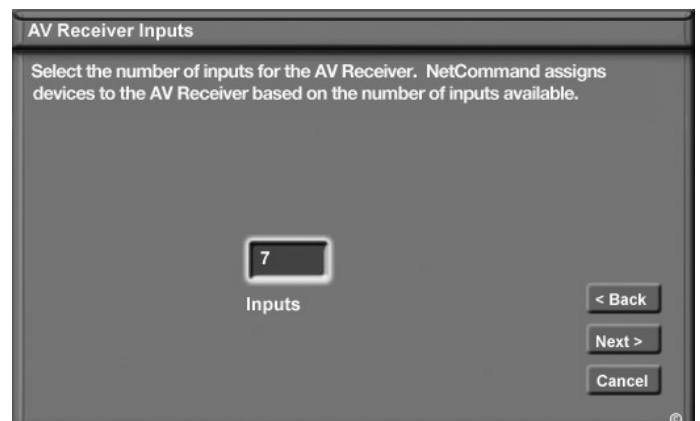

Figure 9. A/V receiver Input screen

Edit NetCommand®: Add an A/V Receiver, continued

A/V Receiver (AVR) Input Learn Screen

Figure 10

NetCommand can now learn the remote control signals used to select each input on the A/V receiver.

1. Press ADJUST ◀ or ▶ on the TV remote to select the check box for each function to be learned.
2. Press ENTER and the function name will begin to flash to confirm the ready-to-learn status.
3. Press the button on the A/V receiver's remote control that corresponds to the selected function. A check mark will appear and the function name will stop flashing. This confirms the signal learned status.
4. To test the learned command, press ENTER on the TV remote. The A/V receiver will perform the selected function. The A/V receiver needs to be turned on and the IR emitters properly placed for the test to be successful (see page 32 for IR emitter placement).
5. To customize the input names, press ADJUST ▶ to move to the Input Name text box and then press ADJUST ▲ or ▼ and ENTER to select each letter of the name. These names will appear on the Review screen as the A/V receiver's input names, and should match the names the A/V receiver shows in its own display.
6. To erase the learned input signal, highlight the check box for that input and press CANCEL.
7. Repeat for each connected input.
8. When the input selection signals have been learned and the inputs named, press ADJUST ▶ to select **Next>** and move to the A/V receiver Learn screen.

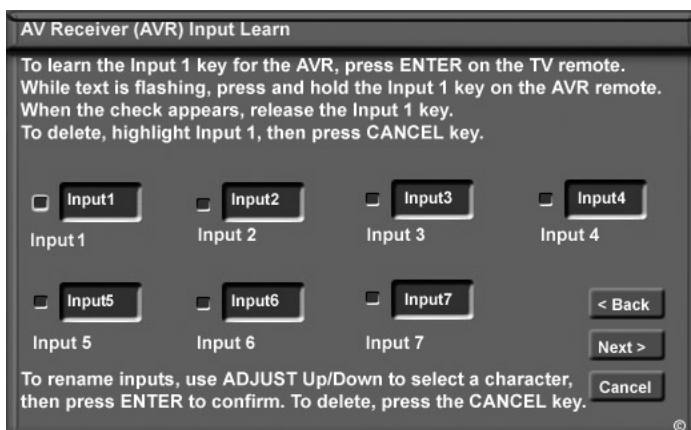

Figure 10. A/V receiver Input Learn screen

A/V Receiver (AVR) Learn Screen

Figure 11

1. Press ADJUST ▲ or ▼ on the TV remote to select the check box for each function to be learned.
2. Press ENTER and the function name will begin to flash to confirm the ready-to-learn status.
3. Press the button on the A/V receiver's remote control that corresponds to the selected function. A check mark will appear and the function name will stop flashing. This confirms the signal learned status.
4. To test the learned command, press ENTER on the TV remote. The A/V receiver will perform the selected function. The A/V receiver needs to be turned on and the IR emitters properly placed for the test to be successful (see page 32 for IR emitter placement).
5. Repeat for each function to be learned.
6. To erase a learned function, highlight the check box for that function and press CANCEL.
7. When the function signals have been learned, press ADJUST ▶ to select **Next>** and move to the Name screen.

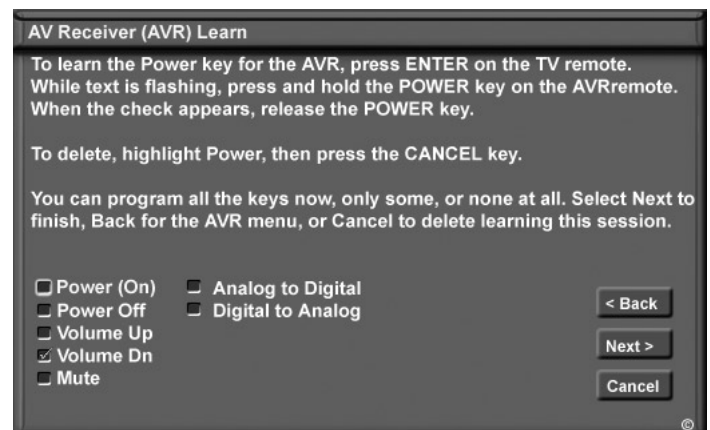

Figure 11. A/V receiver Learn screen

IMPORTANT

When learning remote control signals, point the device's remote at the TV screen

Edit NetCommand®: Add an A/V Receiver, continued

Name Screen

Figure 12

The Name screen allows you to change the default name for the A/V receiver to a custom name of up to eight characters (including a blank space), selecting from letters, numbers, and nine different characters. Using the TV's remote, press ADJUST ▲ or ▼ to select each letter, then press ENTER to move to the next position. Press CANCEL to delete the current letter and move back one character position. When in the first position, the CANCEL button will return the name to the default name.

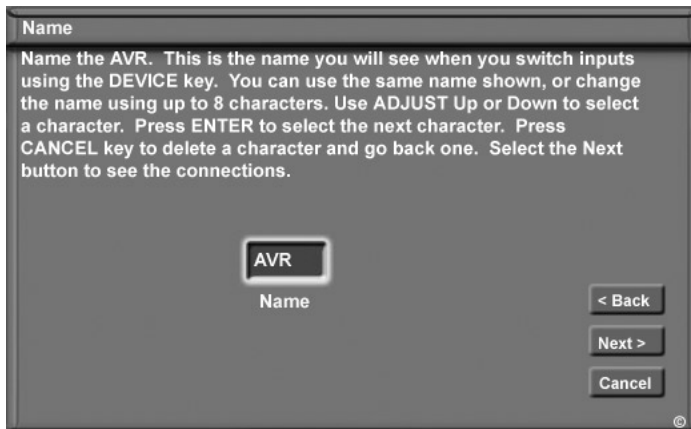

Figure 12. Name screen

Audio Output to AVR Screen

Figure 13

Use this screen to select which A/V Receiver input is connected to AUDIO OUTPUT on the TV back panel. Press ADJUST ► to select **Next>** and move to the Finish screen.

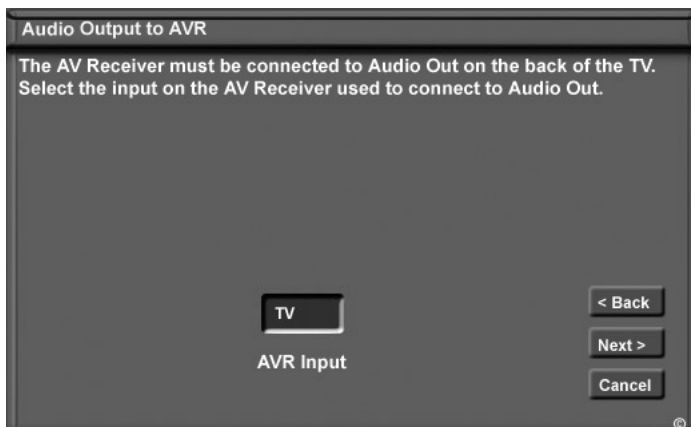

Figure 13. Audio Output to AVR screen

Finish Screen

Figure 14

To finalize your selections and complete the A/V receiver setup, select **Finish** from the Finish screen.

Note: If you connected the audio output of other devices directly to the A/V Receiver, you must use the “Change” function of the Edit NetCommand menu and select each device to assign the correct A/V Receiver input to be used with each device.

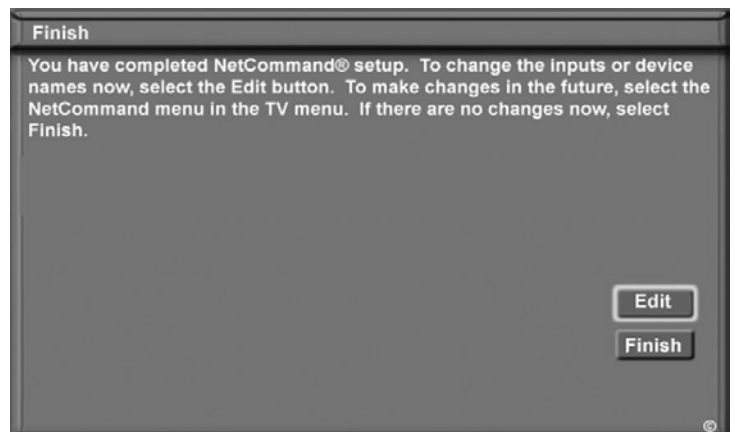

Figure 14. Finish screen

Note: To change any of the inputs or names for the devices, or add devices not included in the initial settings, select Edit to display the Edit NetCommand menu.

IMPORTANT

NetCommand does not allow you to delete an A/V receiver or change the audio connections for a device (such as the TV or a DVD player) if the A/V receiver is currently being used.

To delete or change the A/V receiver audio connections, you must be listening to the TV speakers.

Edit NetCommand®: Add Devices

Mitsubishi's NetCommand allows you to edit your home theater configuration. You can add new devices, change device settings and connections, delete devices and learn remote control IR signals not already in NetCommand memory.

Edit NetCommand Screen

Figure 15

If you selected Edit when you were at the Finish screen, the Edit NetCommand screen displays. Your choices are:

Add

Add a new device to the NetCommand setup. "Learn" the remote control signals of devices listed as "Other" brands. See Figure 16.

Change

Change the brand/model, input connections, or name of a device already listed in the configuration. "Learn" the remote control signals of devices listed as "Other" brands. See Figure 25.

Guide

Edit TV Guide On Screen® ZIP code and input selections. See the separate *TV Guide On Screen Interactive Program Guide User's Manual* for more information about customizing the Guide. See Figure 5.

Review

View a list of all devices and input connections in the NetCommand home theater configuration, including the A/V receiver. This is also where you can turn On or Off unused TV inputs or devices. See Figure 6.

Delete

Remove a device or erase the complete NetCommand home theater configuration. The learned remote control signals are erased when the associated device is deleted. See Figure 26.

Initial

Start the setup at the beginning. This button only becomes available after deleting the complete configuration, or if NetCommand was not set up when the TV was first powered On. See Figure 2.

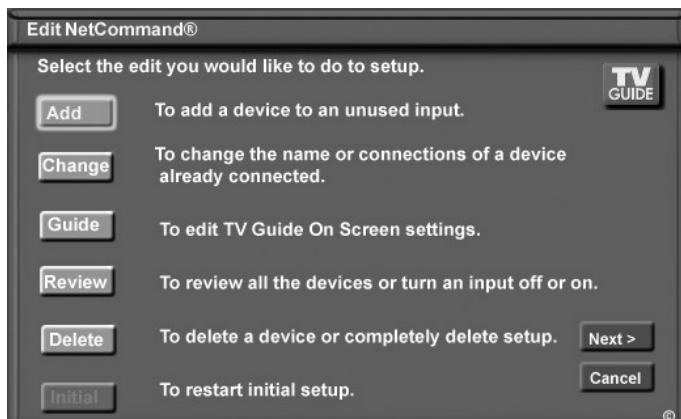

Figure 15. Edit NetCommand screen

Add Screen

Figure 16

Select "Add" from the Edit NetCommand screen, and the New Device screen will display. Select the Device type that you would like to add. You may add your A/V receiver (if not added in Initial setup) Cable Box, Camcorder, SAT (satellite), DVD, Laser Disc, PC and VCR.

At the next screen, choose the manufacturer. If you choose "Other" for the manufacturer, the device (A/V receiver, Cable, SAT, DVD or VCR) can be learned. For device types Laser Disc, Camcorder, Game and PC, the "Learn" screen is skipped. There is no NetCommand support or learning for these devices.

At the next screen, you can keep the default Name or select a custom Name for the device, using ADJUST ▲ or ▼ to select letters A–Z, numbers 0–9, and/or symbols (!.&!/*- and blank) for each character of the name you would like for the selected channel.



Figure 16. Add screen

Hint: The cable box and satellite receiver learn screens include PVR functions.

Edit NetCommand®: Add Devices, continued

[Device] Screen

Figure 17

If you selected “None” for a device type during initial setup, you can later add a device with this screen. This screen also opens when you select the Change option in the Edit NetCommand screen.

The sample screens here show the choices for adding a VCR; similar screens will appear for any satellite receiver, DVD player, or cable box.

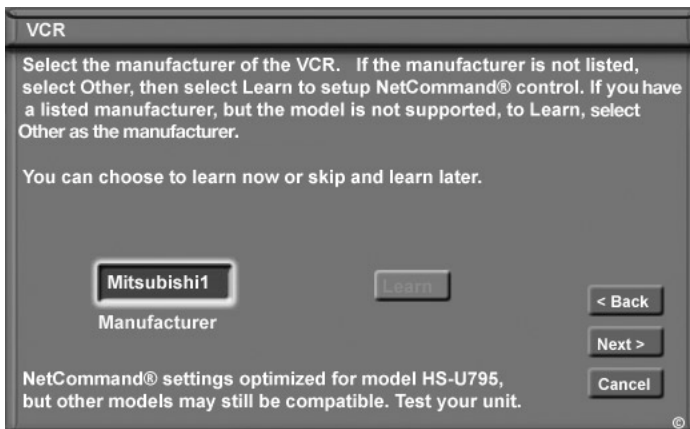

Figure 17. [Device] screen

Choose ONE of these options:

- Select a recognized manufacturer. The model number optimized for NetCommand will display at the bottom of the screen. If a number follows the manufacturer’s name, (example: Mitsubishi 1), this indicates additional models are optimized for that manufacturer. For many device types, non-listed models will operate in the same way as the listed models and you can still use the pre-loaded setting.

After selecting **Next>**, the screens that follow are: the Name Screen (Figure 20), Connection screen (Figure 21) and specialized device screens (Figures 22-24), ending with the Finish screen (Figure 27).

- Select “Other,” then highlight “Learn” and press ENTER. This will allow you to have NetCommand learn the remote control signals of this new device.

After selecting “Learn” and pressing ENTER, the screens that follow are: [Device] Learn screen (Figure 18), [Device] Advanced Learn screen (Figure 19), Name screen (Figure 20), Connection screen, (Figure 21) and specialized device screens (Figures 22-24), ending with the Finish screen (Figure 27).

- Select “Other”, skip Learn and select **Next>**. This will allow the device to appear and will allow NetCommand to switch inputs to use this device. However, NetCommand will not be able to control this device. Later you may use the “Change” option in the Setup menu to learn the remote control signals.

After selecting **Next>**, the screens that follow are: the Name Screen (Figure 20), Connection screen (Figure 21) and specialized device screens (Figures 22-24), ending with the Finish screen (Figure 27).

[Device] Learn Screen

Figure 18

Shown only if “Learn” was selected

1. Press ADJUST ▲▼◀▶ to select the check box for each function to be learned.
2. Press ENTER and the function name will begin to flash to confirm the ready-to-learn status.
3. Press the button on the device’s remote control that corresponds to the selected function. A check mark will appear and the function name will stop flashing. This confirms the signal learned status.
4. To test the learned command, press the ENTER button on the TV remote while the learned function is still highlighted. The device should perform the selected function. The device needs to be turned on and the IR emitters properly placed for the test to be successful (see page 32 for IR emitter placement).
5. Repeat for each function to be learned.
6. To erase a learned function, highlight the check box for that function and press CANCEL.
7. When the function signals have been learned, press ADJUST ▶ to select **Next>** and move to the [Device] Advanced Learn screen.

NOTE: When learning the device’s remote control signals, point the device’s remote control at the TV screen.

Hint: If the device’s remote control uses a single button for both Power On and Power Off, don’t learn the Power Off function.

Edit NetCommand®: Add Devices, continued

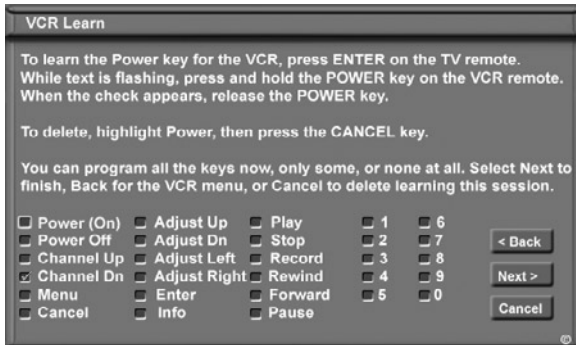

Figure 18. [Device] Learn screen

[Device] Advanced Learn Screen

Figure 19

After learning the basic device keys, the [Device] Advanced Learn screen allows you to learn any special keys for your device. Most common IR remote control signal formats can be learned by NetCommand.

A table of specialized device keys is shown in Appendix F. You only need to learn the functions your devices respond to and can ignore the functions that do not apply to your device.

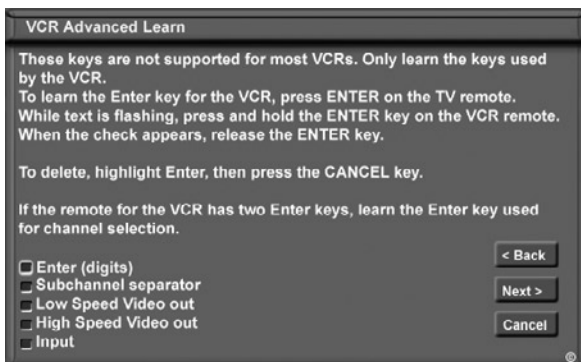

Figure 19. [Device] Advanced Learn screen

Name Screen

Figure 20

The Name screen allows you to change the default name for each device to a custom name of up to eight characters (including a blank space), selecting from letters, numbers and nine different characters. Press ADJUST▲ or ▼ to select each letter, then press ENTER to move to the next position. Press CANCEL on the remote

to delete the current letter and move back one character position. When in the first position, the CANCEL button will return the name to the default name.

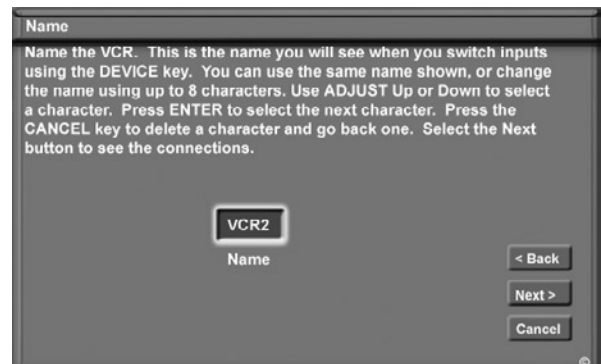

Figure 20. Name screen

Connection for [Device] Screen

Figure 21

Select the TV and A/V receiver inputs to which the device is connected. Connect only audio to the A/V receiver. The A/V receiver may need configuring for digital audio.



Figure 21. Connection for [Device] screen

Edit NetCommand®: Add Devices, continued

The screens described below may not be necessary for your device setup. If they do not display automatically on screen, they are not required.

VCR for Recordings Screen

Figure 22

Select the VCR to use for making analog recordings through NetCommand or the TV Guide On Screen® system. The VCR inputs must be connected to RECORD OUT on the TV, which outputs analog signals converted from digital.



Figure 22. VCR for Recordings screen

RF Connection for Cable Screen

Figure 23

Use the RF Connection for Cable screen to enable the TV's remote control to change channels on the cable box and to enable VCR recording from the cable box. This screen displays only when adding or changing a cable box. If your cable box is connected to a TV antenna input, check the RF check box. Select the TV antenna input that is used with the cable box. Select the channel number used for output by your cable box from the choices listed (003, 004, 005); you can now change channels on the cable box using the TV's remote control. If the cable box is also connected to a VCR for recording, select that VCR.

If your cable box is connected using audio/video or component cables, make sure the RF check box is unchecked. Then the next screen will be Connection (Figure 21), to allow selection of the TV input used with the cable box.

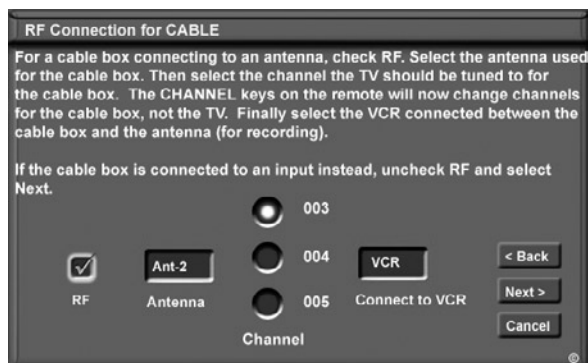

Figure 23. RF Connection for Cable screen

IR Code for [Device] Screen

Figure 24

This screen only displays if an added device has the same IR code as a previously added device of the same type and manufacturer. You can specify the IR setting for the new device. For example, for the second Mitsubishi VCR you can specify the IR Code setting to VCR-B, if the primary Mitsubishi VCR is using the VCR-A IR code.

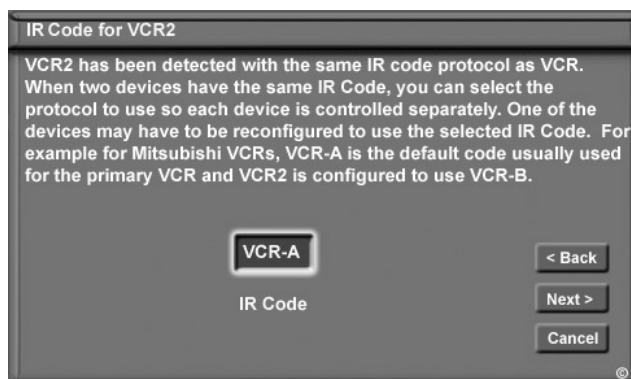

Figure 24. IR Code for [Device] screen

Edit NetCommand®: Change or Delete Devices

Change Device Screen

Figure 25

Selecting Change from the Setup menu screen displays the Change screen. To change a device, select the device by name, not type. You can change the name or input connections to the TV and A/V receiver. If “Other” was selected for the manufacturer then you can also “Learn.” The rest of the screens that follow are the same as when you Add a device.



Figure 25. Change screen

Delete Device Screen

Figure 26

Selecting Delete from the Setup menu displays the Delete screen. You can choose to delete a single device by selecting the device you would like to delete, or you can delete the entire NetCommand configuration. After you have chosen the device, or the entire configuration, you will be prompted to confirm your choice to delete. If you select the Entire Configuration, the Initial button becomes available on the Edit NetCommand screen. If you delete a device that you learned the remote control signals for the learned signals are erased.



Figure 26. Delete screen

Finish Screen

Figure 27

To finalize your selections and complete the NetCommand setup, select **Finish** from the Finish screen.

Note: To change any of the inputs or names for the devices, or add devices not included in the initial settings, select Edit to display the Edit NetCommand menu.

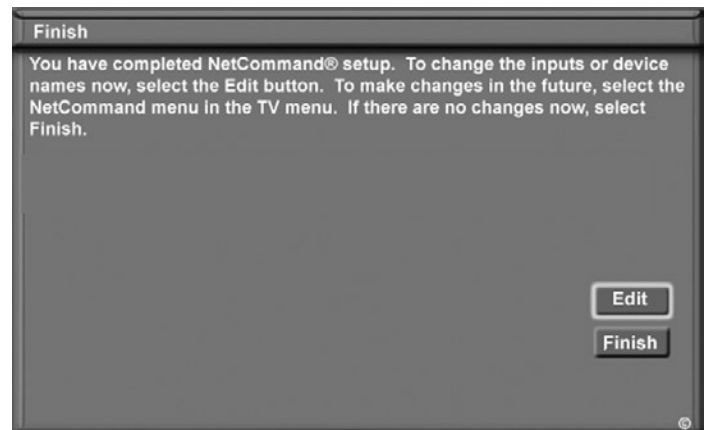

Figure 27. Finish screen

IMPORTANT

NetCommand does not allow you to delete a device or change the connections for a device (like a VCR or a DVD player) if the device (input) is currently being displayed by the TV.

Switch the TV to a different device from the one you are changing or deleting. To change the A/V receiver, you need to be listening to the TV speakers.

IMPORTANT

NetCommand must be set up and the IR emitters properly placed for your cable box and VCR so the TV Guide On Screen system can control these devices.

IEEE 1394 Devices and NetCommand® Control

See pages 33 and 34 for information regarding compatible IEEE 1394 devices and connection styles. The TV is not able to control IEEE 1394 devices that use other types of control protocols. Incompatible digital audio, video and/or control information will still be able to pass from one device through the TV to another device on the network. These incompatible devices may not appear on the Device Selection menu or in the Review screen of the Edit NetCommand menu.

NetCommand Control of Digital Devices Using the “Learn” Feature.

Some IEEE 1394 devices, such as cable boxes or satellite receivers, will not have compatible digital control signals or require the use of the device’s own remote control. Some of these IEEE 1394 devices will not display on-screen information through the IEEE 1394 connection and will require using an analog connection for on-screen displays. In many cases, to control these digital devices, the Learning feature of NetCommand can be used.

1. Place an IR Emitter for NetCommand in front of the device’s remote control sensor (see IR Emitters, page 32).
2. On the Name for 1394 Device screen (Figure 29, page 54) use ADJUST and ENTER to check mark the Analog Connection box.
3. Select the device type on the IEEE 1394 Device Type screen (Figure 30, page 55) of SAT or similar tuning device
4. If desired, using the ADJUST buttons enter a custom Name on the Name screen (Figure 20, page 50).
5. At the Device screen, Select “Other” as a manufacturer and then highlight “Learn” and press Next (Figure 31, page 55).
6. Follow the device learning instructions found on the screen(s) or in the Edit NetCommand section of Chapter 3.
7. The Connection screen (Figure 32, page 55) follows the learning screens. If analog connections are used, select the correct inputs. If only digital connections are used, do not check the video or audio boxes.
8. Proceed with the Finish screen.

This will allow NetCommand to use the learned remote control signal to control these IEEE 1394 devices.

Note: When using the NetCommand learning feature for IEEE 1394 devices that do not have analog connections, the GUIDE function will require pressing GUIDE twice. The first press of GUIDE will display the TV’s digital channel guide. The second press will display the program guide for the device if an IEEE 1394 Guide is available.

Adding IEEE 1394 Devices Automatically

Adding IEEE 1394 Devices Automatically

Addition of IEEE 1394 devices is a special case of NetCommand setup because the devices are detected automatically. You review, edit, and delete these devices through NetCommand just as you would any other devices.

When you connect an IEEE 1394 device to the TV network and power it on, the new device automatically announces its presence. This process is called device discovery and can take up to one minute.

Some non-audio/video or incompatible IEEE 1394 devices, such as personal computers (PCs), may not announce their presence to the TV. The TV is not able to show these devices in the Device Selection menu. They can, however, coexist and are still available to other devices on the IEEE 1394 network that are compatible with these non-audio/video devices.

Try using the Cable/SAT/DTV position of the TV remote control to see if it can control operation of IEEE 1394 cable boxes and satellite receivers. If not, use the remote control that came with the device.

New 1394 Device Screen

Figure 28

When your TV discovers a new IEEE 1394 device, the New 1394 Device screen appears. Select "Add" or "Do Not Add" depending on whether or not you want the device added to the Device Selection menu. If the IEEE 1394 device does not provide audio and video, you may not want to add that device to the TV's Device Selection menu. Devices that were discovered but not added to the Device Selection menu will still be listed in the Review screen of the Edit NetCommand® menu.

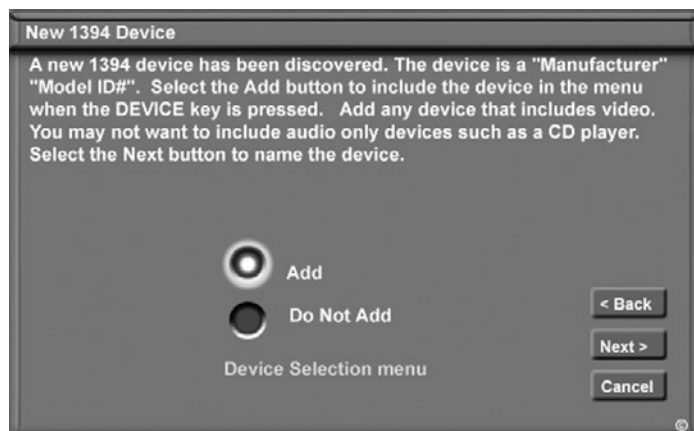

Figure 28. New 1394 Device screen

Name for 1394 Device Screen

Figure 29

If you choose to add the discovered IEEE 1394 device, the Name for 1394 Device screen appears. Enter a new name for the device or use the default name that appears automatically. The name used in this screen is the name that appears in the Device Selection menu.

The DV option applies only to digital camcorders at this time and is typically detected automatically by the TV. If your camcorder uses DV formatting but the box is unchecked, add the check mark manually.

To use the analog capability of some IEEE 1394 devices, such as some DVCRs and cable boxes, check the Analog Connection box.

- Some DVCRs, for example, can record and play as VHS or S-VHS in addition to D-VHS. This allows you to play analog rental tapes or analog tapes from your established library or to make analog recordings from an antenna or cable system.
- Some cable boxes with IEEE 1394 connections require an analog connection for on-screen guides and emergency notices.

Note: You never need to check both the DV and Analog Connection check boxes for a device.

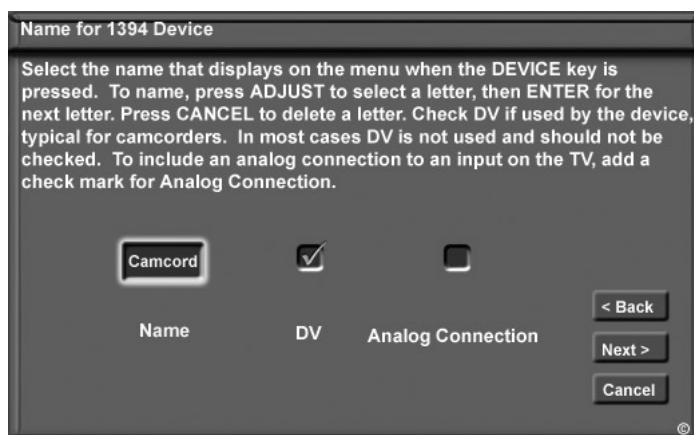

Figure 29. Name for 1394 Device screen

Adding IEEE 1394 Devices Automatically, continued

IEEE 1394 Device Type Screen

Figures 30 and 31

If the new IEEE 1394 device is also connected using analog inputs, you will need to define the device type. Select the type of device, such as a VCR.



Figure 30. IEEE 1394 Device Type screen

Once the device type is selected, then the Device screen is displayed so the manufacturer can be selected. If the manufacturer is listed, then you may be able to control this device while it is operating as an analog VCR. For example, if the IEEE 1394 device you have added is a Mitsubishi DVCR, and you have selected an analog connection as a second connection, then you will select Mitsubishi for the manufacturer. If the manufacturer is not listed, select “Other” and use the Learn screens

Be sure to place an IR Emitter in front of the remote control sensor, just as you have done for other NetCommand® devices. It is necessary to use the IR Emitter only when the DVCR is being used as an S-VHS or VHS VCR. When the DVCR is playing or recording digital signals in D-VHS, the TV will control the VCR through the IEEE 1394 cable.

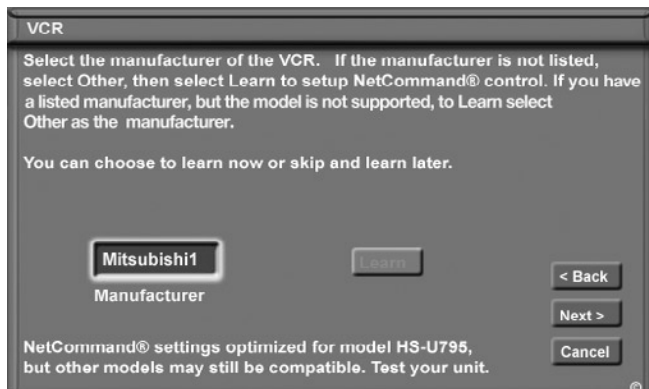

Figure 31. Device screen

Connection Screen

Figure 32

Select the TV input that you used when you connected the video or S-Video cables. You may also select the TV or A/V receiver input you used when you connected the stereo audio cables.

The playback and record control of some devices may still operate via the IEEE 1394 cable automatically, even though you must use the video or S-video cable for the picture. In this case, when you select the device, be sure to select analog (not digital) from the pop-up that opens when the device is selected from the Device Selection menu. With this setup, the picture is shown via the analog connection but control is through the IEEE 1394 connection.

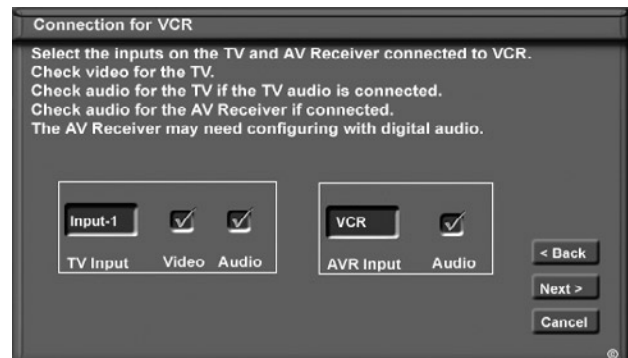

Figure 32. Connection screen

Finish Screen

Figure 33

To finalize your selections and complete the NetCommand setup, select **Finish** from the Finish screen.

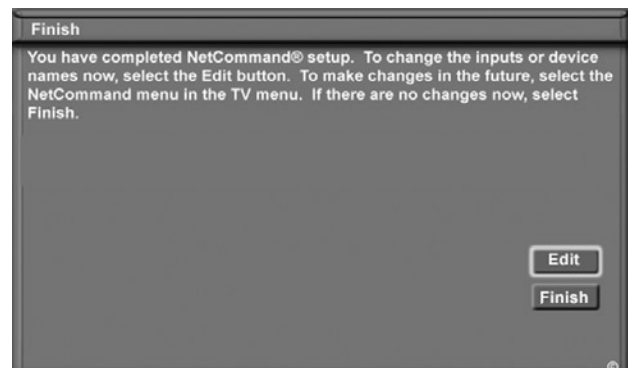

Figure 33. Finish screen

NetCommand® Functions

Device Selection Menu	58
Using the Device Menu Button to Display Menus	59
Using the GUIDE Button to Display ChannelView™ and Menus . . .	60
NetCommand®-Controlled Recordings.	61
Peer-to-Peer Connections	63
Using A/V Discs	64

Device Selection Menu

When you press DEVICE on the TV's remote control, the Device Selection menu (Figure 1) displays. If NetCommand® has not been set up, the Device Selection menu allows you to select an input for viewing. If NetCommand is set up, the Device Selection menu allows you to select the device for viewing, select audio from the TV speakers or A/V receiver, power compatible devices On or Off, and verify the destination of signals. On the Device Selection menu, the device or input currently displayed appears as a gold-colored icon.

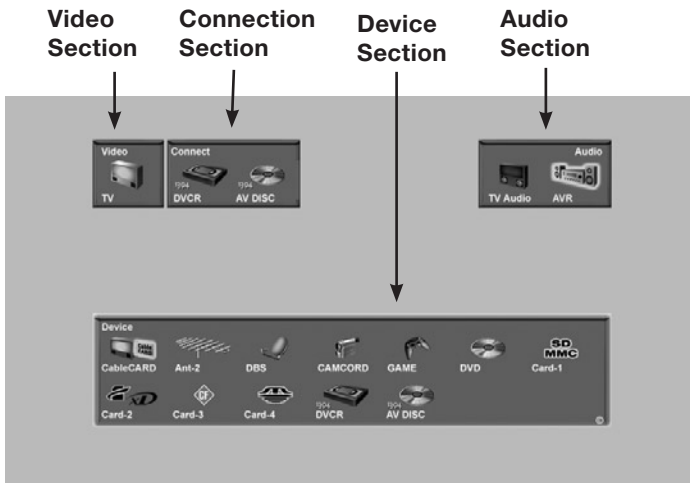

Figure 1. Device Selection Menu with NetCommand

Power On/Off Devices

Devices that have separate On and Off remote control buttons will power On automatically when you select the device and will power Off when you turn off the TV. For devices that do not power On or Off automatically, display the Device Selection menu, press ADJUST ◀ or ▶ to highlight the device icon and press POWER on the remote control. For the A/V receiver, press AUDIO to move the navigation to the Audio Section. Highlight the A/V receiver icon and press POWER. If you press POWER on the remote control when the Device Selection menu is not displayed, the TV will turn Off.

Device Section

To select another device or input, press ADJUST ▲▼◀▶ on the TV's remote to move the highlight. Press ENTER to select the device to view and hear. The TV inputs are automatically changed. If NetCommand is set up, the inputs on compatible A/V receivers are automatically changed at the same time.

Video Section

The destination of the device highlighted in the Device Section is displayed here as a TV icon.

Connection Section

The Connection Section shows the recording in progress and the device that is recording from the source. For example, if the Digital VCR (D-VCR) is currently recording, when you move the highlight to the Ant-1 icon, the D-VCR icon appears in the Connection Section. This icon disappears when you move the highlight to another icon or press CANCEL to stop recording.

Audio Section

When a NetCommand pre-memorized or learned IR controlled A/V receiver has been connected to the TV and added to NetCommand Setup, an AVR icon will appear in the audio section. Press AUDIO to change navigation to the audio section. Then press ADJUST ◀▶ to select the TV speakers icon or the A/V receiver icon. Press ENTER to change the audio selection. Press DEVICE to return the navigation to the Device Section.

PIP Device Selection Menu

Figure 2

The PIP Selection menu displays when you press the PIP DEVICE button on the remote control. This menu has the same general format as the Device Selection menu. The source for the Video Section is the sub picture and the Audio and Connection Sections are not available.

Use ADJUST ▲▼◀▶ to move the highlight to the device to show in the PIP or POP screen, then press ENTER. Device icons that are grayed out are not available for use as PIP or POP sources or with the current source.

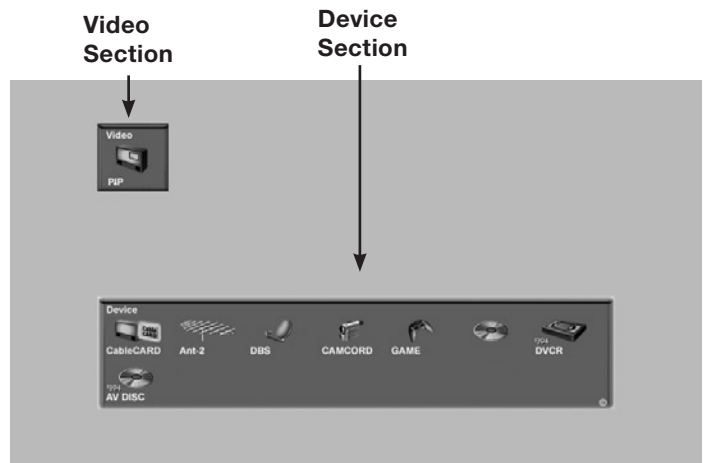

Figure 2. PIP Device Selection Menu

IMPORTANT

If a device does not respond to separate On or Off remote control signals, the manufacturer has not provided that ability for the device.

Using the Device Menu Button to Display Menus

Device Menu

If the input is a VCR or DVD, and NetCommand is set up, press DEVICE MENU once to display the transport menu for the current device (figure 3). Press DEVICE MENU a second time to display the menu for the current device source, if available.



Figure 3. Transport menu

When used with the TV Guide On Screen, DEVICE MENU displays or removes TV Guide's menu information. See the *TV Guide On Screen Interactive Program Guide User's Manual* for detailed information.

IR Controlled Devices

For a NetCommand compatible traditional IR controlled device, pressing DEVICE MENU once or twice will display the menu for that device. While the menu for the device is displayed, press ADJUST ▲▼◀▶ and ENTER to navigate the screen. For some NetCommand traditional devices, you will also be able to use the number buttons and other additional buttons on the TV remote. For traditional DVD players, DEVICE MENU is also known as the setup menu.

CableCARD™ Menu

Figure 4

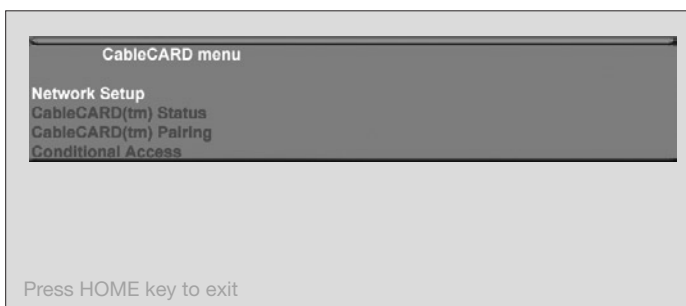

Figure 4. Possible Device Menu for CableCARD

When using a CableCARD, pressing DEVICE MENU will display a list of up to 8 links to applications that contain basic CableCARD information made available from your cable provider. Press ADJUST ▲ or ▼ to move through the application links. To select a link (blue text) to an application, press ADJUST ▲ or ▼ to highlight the link, then press ENTER to access the linked page. Pressing DEVICE MENU will return to the CableCARD menu screen and pressing HOME will return to TV viewing. The

screen shown is an example of the type of screen that may display. Specific screen menus are sent by your cable provider.

If there are technical problems with the CableCARD, an error screen will automatically display with information that may be needed by your Cable provider when you call them for assistance.

Moving Through Other CableCARD Screens

In addition to CableCARD menus, other CableCARD application screens may display and require you to make additional selections. While CableCARD application screens are customized in each area, some general rules apply in using these screens on your Mitsubishi television.

1. Blue text denotes a link to another screen. Press ENTER to move to the next application. When screens do not have blue text, there are no more links.
2. You cannot move backward through the links. If you want to exit the CableCARD system, press HOME to exit and return to TV viewing. CANCEL may not work with some CableCARD screens.

All information on these application screens is provided by your local cable company. Please contact your cable provider if you have any problems with the application screen displays.

IMPORTANT

Most CableCARD screens show only status or diagnostic information and do not allow you to make changes. These screens are meaningful only to your local cable provider.

Using the GUIDE Button to Display ChannelView™ and Menus

The GUIDE Button

Please refer to the separate TV Guide On Screen® User's Guide for details about using the GUIDE button with TV Guide On Screen. When you are not using the GUIDE for the TV Guide screens, pressing GUIDE allows you to see NetCommand® controlled program guides or menus.

GUIDE and Devices (1394 or IR Controlled)

For NetCommand-compatible satellite receivers and some cable boxes, GUIDE displays the on-screen programming guide for the receiver or cable box. Press ADJUST ▲▼◀▶ and ENTER to navigate the displayed Guide. For NetCommand-compatible satellite receivers, you may also be able to use the number or other additional buttons.

For NetCommand-compatible DVD players, GUIDE displays the DVD disc “top” menu (not the setup menu). For A/V Discs, press GUIDE to display the Track List screen. For IEEE 1394 devices with digital connections, press GUIDE twice to display the device's Guide. For memory cards, press GUIDE to display a JPEG thumbnail menu (video) or a playlist menu (audio).

GUIDE and the Device Selection Menu

For compatible traditional VCRs, press GUIDE when the VCR is highlighted on the Device Selection menu to change the VCR's input.

When the A/V Receiver icon is highlighted in the Audio Section, pressing GUIDE switches the A/V Receiver from analog audio to digital audio and vice versa, if supported.

GUIDE and the Record To Menu

When in the Record To menu, pressing GUIDE will display the current list of programmed recordings. Please see Record List, page 62 for more information.

GUIDE and ChannelView

Figures 5 and 6

ChannelView is available for antenna inputs not associated with TV Guide. Press GUIDE while viewing ANT-1 or ANT-2 to display a list of available memorized digital channels (D) and analog (A) channel information (if available from the broadcaster). This list is called ChannelView™

ChannelView for digital channels will show the major and sub-channels (or bitstreams). Analog channel information will display as sent. Press ADJUST ▲ or ▼ to scan through all the channels in memory one by one. To cycle through the choices quickly, press CH ▲ or ▼.

For detailed program information, press ADJUST ▶, to return to basic information press ADJUST ◀. This information is sent by the broadcaster. If limited data is shown or no program data appears, it is because the broadcaster is not sending the information. *This is not a defect of your TV.*

Recording a Current Program

To record a current program, press REC (record) when your program choice is highlighted on the program list in ChannelView. A red “R” will be added after the input name. The TV will immediately switch to the selected channel and start recording.

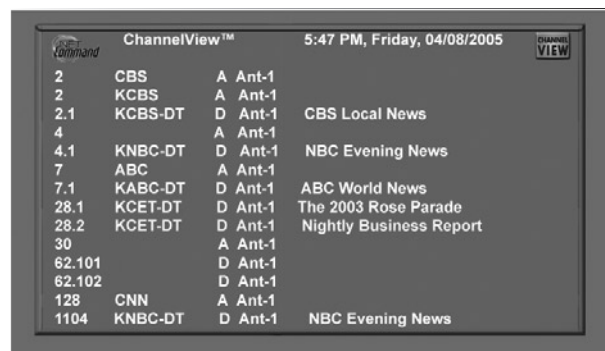

Figure 5. ChannelView screen, current programs

Recording Future Programs

To record a future program, press ADJUST ▲ or ▼ to select the channel you want to record from. For detailed program information, press ADJUST ▶, to return to basic information press ADJUST ◀. Press REC (record) when your choice is highlighted. A red “R” will be added after the input name. The message, The recording has been added to the Record List will display. To view, change or cancel a recording, use the Record List (page 62).

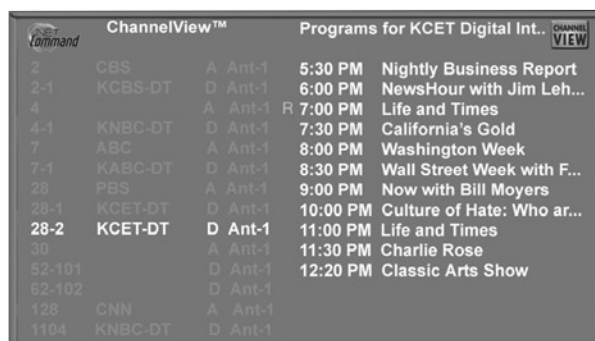

Figure 6. ChannelView screen, future programs

IMPORTANT

For complete ChannelView information to be refreshed daily, the TV must be powered Off from 5 to 15 minutes a day, depending on the number of channels in memory. If the TV loses power, the program listings will be temporarily lost.

NetCommand®-Controlled Recordings

Setting up Recordings

Figure 7

Through NetCommand, you can automatically start and stop recordings and send signals from one playback device to a recording device. Recordings can be made on recordable devices connected to the TV.

The TV can convert digital channels and IEEE 1394 device signals to analog signals that can be recorded on NetCommand-compatible analog VHS and S-VHS VCRs.

You can schedule the recording to take place at a later time and program the recording duration for a minimum of 30 minutes and a maximum of six hours (in 30-minute increments). The default is one hour. During the recording, you can view a different device or power off the TV.

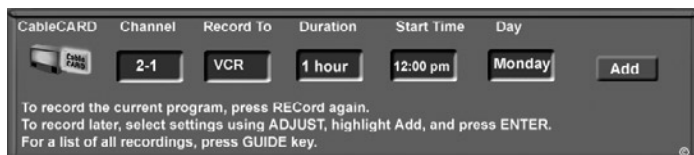

Figure 7. Recording Setup screen

Recording Now

Can be used when viewing Antenna 1 or 2, an IEEE 1394 device, or a non-recording traditional device.

To initiate recording now:

1. Press REC (record) on the TV remote.
2. In the “Record to” section, review the destination device and duration. Use ADJUST ▲ or ▼ to change, if necessary.
3. Press a second time and the recording will start.

Time-Delayed Recording

1. Set the TV to the source you want to record.
2. Press REC (record) on the TV remote.
3. Press ADJUST ◀ or ▶ to select the Record To device, duration time, start time (press ENTER after selecting hour, minutes and AM or PM to set the time) and day, using ADJUST ▲ or ▼ to change. For devices that can select channels, select the channel.
4. Select Add and press ENTER to add the recording to the record list. If your selection is successful, a confirmation message will be displayed. If you pick overlapping times, day(s), or destination devices, you will see a message stating there is a conflict.
5. To exit, press HOME on the TV remote after all recordings have been added.

Record List

Figure 8

Press GUIDE while viewing the Record To screen to see a list of all currently programmed recordings. A maximum of 32 recordings can be scheduled.

To cancel a recording on the Record List, press ADJUST ▲ or ▼ to select the recording, then press CANCEL. To page through the list, press CH ▲ or ▼.

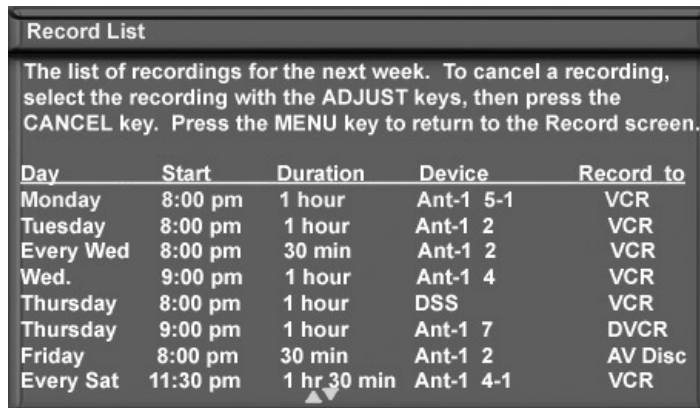

Figure 8. Record List screen

Direct VCR Recording from an Antenna or Cable Source

When your VCR is the current device, REC (record) on the TV's remote control functions the same as the record button on the VCR's remote control or front panel.

To record directly from antenna or cable:

- Method 1
 1. Press DEVICE on the TV's remote to display the Device Selection menu. Highlight the traditional VCR and press POWER to turn on the VCR. If necessary, press GUIDE to select the input the VCR is on, such as Antenna input (or line input).
 2. Press ENTER to switch the TV to the VCR.
 3. Select the correct channel for recording on the VCR and then press REC to start recording. You will need to manually stop the recording at the end of the program
- Method 2

With the VCR as the current recording device, press the DEVICE MENU button to display the VCR's menu, in which you can schedule a delayed recording directly from antenna or cable.

To record from ANT-1, ANT-2 or other devices, see NetCommand Controlled Recordings or refer to the *TV Guide On Screen® User's Guide*.

NetCommand®-Controlled Recordings, continued

Copy-Protected Material

When attempting to record copy-protected material, the Record functions of the NetCommand and IEEE 1394 systems may be prevented or stopped. If you have a recording that is tagged “Record Once,” NetCommand will change the tag to “Record No More.”

Restrictions for Traditional VCRs

- Your VCR should be connected directly to the RECORD OUTPUT AUDIO and VIDEO outputs.
- The VCR must be set manually to “Line Input.” Display the Device Selection menu, highlight the VCR and press GUIDE to change VCR inputs.
- If NetCommand is set up, the TV can select channels on compatible cable boxes for recordings. Leave the cable box turned on.
- If the source device or recording device does not have separate power On and Off features, then leave that device powered On.
- You cannot record from source devices connected to the TV Component inputs or HDMI 1 or 2 connections.

Peer-to-Peer Connections

What is a Peer-to-Peer Connection?

Figure 9

A peer-to-peer connection allows the IEEE 1394 devices in your TV network to talk to each other without the further need of TV intervention once the peer-to-peer connection is established. With the connection established, you can turn off the TV or use it to watch another device.

For example, the TV can set up a connection for an IEEE 1394 cable box that sends a program to another device for viewing. NetCommand establishes the connection between the two devices. Set up a recording over a peer-to-peer connection the same as you would any other NetCommand-controlled recording.

NOTE: Analog or traditional (non-digital) devices can not be used for peer-to-peer connections.

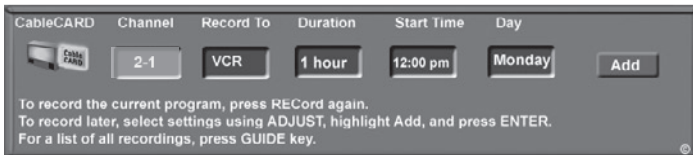

Figure 9. Recording Setup screen for peer-to-peer connection

Setting up a Non-Recording Peer-to-Peer Connection

To establish a peer-to-peer connection:

1. Select the source in the Device Selection menu.

2. Press RECORD or CONNECT on the TV remote control to open the Recording Setup screen.
3. In the “Record To” section of the Recording Setup screen, review the destination device and duration of the connection. Change if necessary.
4. Press RECORD or CONNECT a second time to establish the connection.

NOTE: Multiple peer-to-peer connections can operate simultaneously, sometimes with the same source device. Please note that peer-to-peer connections are NOT listed on the Record List screen.

Cancelling a Peer-to-Peer Connection

To cancel a peer-to-peer connection:

1. Press DEVICE to open the Device Selection menu.
2. Highlight the source device in the Device Selection menu.
3. Confirm that the on-screen icon for the peer-to-peer connection is in the Connection Section next to the TV icon
4. Press CANCEL.

The peer-to-peer connection ends and the destination icon is removed. If there is more than one peer-to-peer connection for the same device, all the connections are cancelled.

Using A/V Discs

A/V Disc Search

NetCommand is able to search to a specific time in a recording on an IEEE 1394 A/V Disc.

1. Start the desired track's playback on the A/V disc.
2. Use the number buttons to enter the time code position of hours followed by minutes. For example, to enter one hour and twenty-two minutes (1:22) into the track, enter 1, 2, 2.
3. Press ENTER to skip to the time code position.
4. To cancel the request or to start over, press CANCEL instead of ENTER.

Track List Screen

Figure 10

When viewing an A/V Disc, press GUIDE to display its Track List. The time and date it was added, the duration and title will be displayed. Tracks will be listed in date and time order and will vary in size. Press ADJUST ▲ or ▼ to navigate through the Track List. To play a track, select it on the list, then press ENTER. To change pages, press CH ▲ or ▼. To delete a track, select it on the list and press CANCEL.



Channel	Station	Date	Time	Program	Watched
62	KNBC-DT	Su 7/25	8:00 pm	West Wing	N
With the country at a heightened state of alert because suspected terrorists have disappeared, the President wrestles with what message to give his youngest daughter's graduating class at Georgetown.					
45 min	6G	COPY FREE			
02.01	KCBS-DT	Su 8/08	5:30 pm	Chicago Hope	N
04.01	KNBC-DT	M 8/09	5:30 pm	CBS Local News	N
7		M 8/09	8:00 pm	NBC Evening News	Y
1104	KNBC-DT	W 8/11	8:30 pm	NBC Evening News	N

Select a program with the ADJUST keys. Press ENTER to watch the program. Press CANCEL to delete.

Figure 10. Track List screen

Using the Remote Control with an A/V Disc after Selecting It from the Device Selection Menu:

- GUIDE: displays the Track List of recorded programs.
- INFO:
- from within the Track List: displays program description.
 - from outside the Track List: displays A/V disc status.
- PLAY: resumes playback of paused program.
- PAUSE: pauses or resumes playback of program.
- FF/FWD: forward picture search, multiple presses increase the speed.
- REW/REV: reverse picture search, multiple presses increase the speed.
- ADJUST ◀: skips backward 12 seconds per press.
- ADJUST ▶: skips forward 30 seconds per press.
- ADJUST ▲: skips to the end of the track.
- ADJUST ▼: skips to the beginning of the track.
- REC: displays the Record Menu to schedule recordings.
- CANCEL: deletes a highlighted track.
- CH Up/Dn: pages through multiple screens of listed tracks.

TV Menu Operations

Main Menu	66
Setup Menu	67
NetCommand® Menu	69
Record Menu	70
Channel Menu	72
Captions Menu	74
V-Chip Lock Menu	76
Audio/Video Menu	79
Audio Settings	80
Video Settings	81

Main Menu

Setup Menu

Figure 1

Use the Setup menu to select English or Spanish as the language for the menus and on-screen displays. Memorize the available channels for antennas or cable connected to the ANT-1 and ANT-2 inputs. Manually set the time for the TV, or select Auto and the TV will automatically set the time based upon Extended Data Service (XDS) time data. This time data is usually broadcast by your local PBS station. This menu is also used to set the TV timer, and reset the lamp reminder. The TV's software version is displayed on this screen.



Figure 1. Main menu, Setup selected

NetCommand Menu

Figure 2

Add, change, review or delete NetCommand® settings and devices. Enable/disable TV Guide On Screen® or change ZIP code and input selection settings. Change the order of icons on the Device Selection menu. Turn the transport menu off.



Figure 2. Main menu, NetCommand selected

Record Menu

Figure 3

Set up and view recordings and recording defaults. View your customized Record List. If you have more than one digital recording device connected, use this menu to change the default digital Record To device. Set analog recording size.



Figure 3. Main menu, Record selected

Channel Menu

Figure 4

Edit channels for ANT-1 and ANT-2. After memorization, if a channel displays as digital and analog, you can choose to see the channel digitally every time it is selected. Manually add or delete channels from memory, name channels or add your favorite channels to a SQV (SuperQuickView™) list. Displays signal strength of currently tuned digital channels.



Figure 4. Main menu, Channel selected

Captions Menu

Figure 5

Display Closed Captions if sent by the broadcaster, select settings for analog or digital captions.



Figure 5. Main menu, Captions selected

V-Chip Lock Menu

Figure 6

Block or allow programming based upon rating signals sent by the broadcast station, lock by time, or lock the front panel buttons.



Figure 6. Main menu, V-Chip Lock selected

Audio/Video Menu

Figure 7

Reset the A/V Memory to return to the original factory A/V settings for a selected device. Customize the individual audio and video settings. Display a blue screen when viewing a device with no signal, enable/disable Film Mode, or turn the TV speakers on or off.



Figure 7. Main menu, Audio/Video selected

Setup Menu

Setup Menu

Figure 8



Figure 8. Setup Menu

Language

Display the on-screen menus in either English or Spanish (Español). The first time you powered on your TV, you were requested to select an on-screen-menu language. If you choose to change the selection, all menu text will immediately switch to the language of your choice.

To listen to audio in other languages (when available), see the section of this Owner's Guide covering audio settings.

Memorize Channels

For Antenna 1 (Main) or Antenna 2 (Aux)

To start channel memorization, first select an input according to the table below.

Input	Condition
Ant-1 Air	When connected to an indoor/ outdoor antenna
Ant-2 Air	
Ant-1 Cable	When connected to direct cable
Ant-2 Cable	

Press ENTER to start the automatic channel-memorization process. The memorization process is started separately for each antenna selection.

During the memorization process, all possible channels on the selected antenna are scanned twice. Analog channels are scanned first and then the process is repeated for digital channels.

To stop the automatic channel-memorization process before it completes, press CANCEL. Channels memorized before you pressed CANCEL are retained in memory. If you start the memorization process again, all previously memorized channels for the selected antenna input are erased and the process starts over from the beginning.

After memorizing channels, the channels in memory can be accessed in ascending or descending order by pressing CH ▲ or ▼. Select the Channel Menu to access further channel-editing features, such as channel add or delete, channel name, and SQV custom favorite channel memories.

When you use a CableCARD™, the complete list of available channels is provided through the CableCARD. As a result, the Ant-1 channel-memorization options are not available and are shown grayed out on the screen.

In the TV Guide On Screen® system, the channels displayed and the order in which they are displayed in the Guide is independent of the channel-memorization process. Refer to the *TV Guide On Screen Interactive Program Guide User's Manual* for detailed instructions on editing channels shown in this guide.

Clock

Figure 9

You may choose to manually or automatically set the clock that your TV will use for recording or timer functions.

Manual

To manually set the clock, you need to select the current time, current date, time zone for your area and the Daylight Savings time setting.



Figure 9. Time Menu, Setting the Clock Manually

Time

Press ADJUST ▲ or ▼ repeatedly to slowly select the hour or press and hold to quickly select the hour. Press ENTER to move to the minutes options. Press ADJUST ▲ or ▼ to select minutes.

Date

Press ADJUST ▲ or ▼ to select the correct date.

Setup Menu, continued

Time Zone

Select your correct time zone. Press ADJUST ▲ or ▼ to select the time zone (Atlantic, Eastern, Central, Mountain, Pacific, Alaska or Hawaii) for your area. Then press ADJUST ► to move to the Daylight Savings time option.

Daylight Savings Time

Select the Daylight Savings time (DST) option that your state uses. Press ADJUST ▲ or ▼ to select Applies if your state or area uses DST, or Ignore if DST does not apply.

Auto

Select the Time Zone and Daylight Savings time setting, as noted above. You may then tune to a channel (on ANT-1 or ANT-2) that uses Extended Data Service (XDS) time data, typically a PBS channel. The Auto selection will automatically retrieve the correct time and date information from this channel. Be aware that if a channel displays incorrect time information, it is because of information sent from the broadcaster and is not a defect of the TV.

Timer

Figure 10

On/Off

The timer allows you to set up a time when the TV will change the channel and turn on. You select the time and day for the TV to turn on and the device and channel to display. At your preselected time, the timer will turn the TV on and this message will be displayed: “Press a button for the TV to stay on.” Press any button on the remote control within five minutes or the TV will turn itself off.



Figure 10. Timer Menu (Timer On/Off)

Set Day

Select the day or days that the TV will turn on automatically. Press ADJUST ▲ or ▼ to select Daily, Mon-

Fri (Monday through Friday), or the individual days of the week.

Set Time

Press ADJUST repeatedly to slowly select the hour or press and hold to quickly select the hour. Press ENTER to move to the minutes options. Press ADJUST ▲ or ▼ to select minutes.

Device

Press ADJUST ▲ or ▼ to select the device to use when the timer turns on the TV. If the TV is already on, the timer will turn the TV to this selected device.

Channel

When an antenna is the selected device, you may select any memorized channel. Press ADJUST ▲ or ▼ to select the channel and the TV will tune to this channel in memory when the timer turns it on. This includes sub-channels for digital choices.

Lamp Reminder

Select to reset the lamp reminder message after you have changed the lamp cartridge. Press ENTER to reset the lamp reminder. To have an accurate reminder that the lamp cartridge may soon need replacement, reset the lamp reminder only when you replace the lamp cartridge. See Appendix H for detailed information about changing the lamp.

Software Version

For some service-related issues, it may be necessary to know the software version in your TV. This information is displayed on the Setup menu screen.

NetCommand® Menu

NetCommand Menu

Figure 11



Figure 11. NetCommand Menu

Edit

Detailed information regarding setting up and editing the NetCommand menu is found in *Chapter 3*. The Edit NetCommand screens allow you to add new devices and change traditional and IEEE 1394 devices. You can also set up the TV Guide On Screen® system or turn it on or off. Turn devices and unused inputs On or Off, delete a single device or delete the entire setup configuration. If you choose to delete the entire configuration, or if the NetCommand setup was cancelled, deleted or not completed, you can start at the Initial NetCommand screen. The Review screen shows all devices connected to the TV.

Icon Order

Figure 12

The Icon Order screen allows you to arrange the device icon order on the Device Selection menu to a different sequence, for ease of selection and operation.

To change the order, press ADJUST ▲, ▼, ◀, ▶ to highlight the icon to be moved and then press ENTER. Press ADJUST ▲, ▼, ◀, ▶ to move the icon to the desired position and then press ENTER to select the icon.



Figure 12. Icon Order Menu

Transport Menu

Figure 13



Figure 13. Transport Menu

NetCommand uses the Transport menu to control VCRs, DVDs, IEEE 1394 A/V Discs, digital VCRs, and similar devices. If you choose to turn off this menu when viewing the devices, the transport buttons (rewind, play forward, stop, pause and record) on the TV's remote control will continue to operate these devices. In the Device Selection menu selecting a VCR or DVD Player will automatically display the Transport menu. You can re-display this menu by pressing DEVICE MENU.

Select Transport menu functions by pressing ADJUST ▲, ▼, ◀, ▶ and then ENTER. For example, to pause playback, press ADJUST ◀ or ▶ to move to PAUSE, then press ENTER. If a function is not possible, such as record for a DVD Player, the Transport menu button will be grayed out.

Remote Control Transport Buttons

Transport buttons (rewind, play forward, stop, pause and record) on the remote control are located in the bottom section of the remote control.

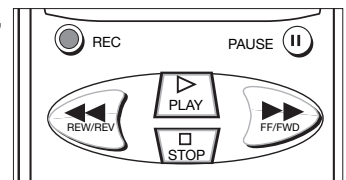

Record Menu

Record

Figure 14

The Record menu allows you to set up recordings, view the record list, and set defaults for your recording devices.



Figure 14. Record Menu

Recording Setup

Figure 15

The recording Setup screen is where you tell the TV what, where, and when to record. There are two ways to open the Recording Setup screen:

- select Record from the Record menu.
- press REC on the remote control when viewing a recordable source.

Your TV can stop recordings automatically and it can send the signals from one external playback device to another external recording device. It is also able to convert digital channels and IEEE 1394 device signals to analog signals. These converted signals can be recorded on NetCommand-compatible analog VHS and S-VHS VCRs connected to the RECORD OUTPUT/VIDEO and AUDIO outputs on the back of the TV.

You can schedule the recording to take place at a later time and program the recording duration for a minimum of 30 minutes and a maximum of six hours (in 30-minute increments). The default is one hour.

When a digital recording is being made, the TV can direct the signals to the recording device using the IEEE 1394 cable. In the case of an analog recording, (as to a VCR) the TV converts the digital signals to analog format and sends the analog output to the VCR through the RECORD OUTPUT jacks.

During the recording, you can view a different device or power off the TV. See Appendix I for more information.

To prevent recording of unwanted material while recording to a VCR or A/V disc, press PAUSE to temporarily stop recording. Press PAUSE again to resume recording.

You cannot record from an analog channel or device or a VHS or S-VHS VCR to a digital recording device such as a DVCR or A/V Disc.

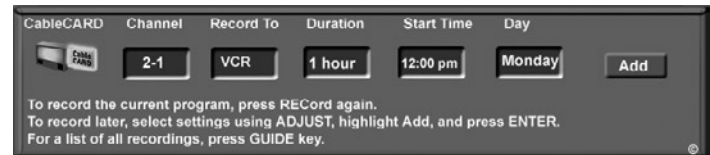

Figure 15. Recording Setup screen

Recording Now

Can be used when viewing Antenna 1 or 2, an IEEE 1394 device, or a non-recording traditional device.

To initiate recording now:

1. Press REC (record) on the TV remote or press ENTER if the Record menu is displayed.
2. Review the Record To (destination) device (VCR) and duration. Change if necessary.
3. Press REC a second time to initiate recording.

Time-Delayed Recording

To initiate a time-delayed recording:

1. Set the TV to the source you want to record.
2. Press REC (record) on the TV remote or press ENTER if the Record menu is displayed.
3. Press ADJUST ▲ or ▼ to select the channel, device to record to, duration time, start time (press ENTER after selecting hour and minutes to set the time) and day.
4. Select Add and press ENTER to add the recording to the record list. If your selection is successful, a confirmation message will be displayed. If you pick overlapping times, day(s), or destination devices, you will see a message stating there is a conflict.
5. To exit, press HOME on the TV remote after all recordings have been added.

IMPORTANT

See Appendix I for a list of recording and viewing combinations available for this TV.

IMPORTANT

Recordings scheduled on this screen are independent of recordings scheduled through TV Guide On Screen®. Recordings scheduled with TV Guide On Screen have priority if there is a conflict between the two recording schedules.

Record Menu, continued

Record List

Figure 16

To see a list of all currently programmed recordings, select the record list option on the Record menu or press GUIDE while viewing the Recording setup screen. A maximum of 32 recordings can be scheduled. To page through the list, press CH ▲ or ▼.

To Cancel Scheduled Recordings

To remove a recording from the record list, use ▲ or ▼ to highlight the scheduled recording and then press CANCEL.

To Cancel a Recording in Progress

1. Press DEVICE to display the Device Selection menu.
2. Highlight the icon for the source device and verify that the icon for the recording device appears in the connection section.
3. Press CANCEL

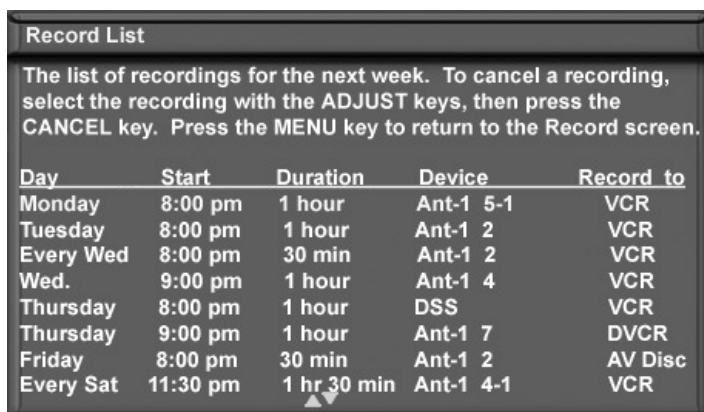

The list of recordings for the next week. To cancel a recording, select the recording with the ADJUST keys, then press the CANCEL key. Press the MENU key to return to the Record screen.

Day	Start	Duration	Device	Record to
Monday	8:00 pm	1 hour	Ant-1 5-1	VCR
Tuesday	8:00 pm	1 hour	Ant-1 2	VCR
Every Wed	8:00 pm	30 min	Ant-1 2	VCR
Wed.	9:00 pm	1 hour	Ant-1 4	VCR
Thursday	8:00 pm	1 hour	DSS	VCR
Thursday	9:00 pm	1 hour	Ant-1 7	DVCR
Friday	8:00 pm	30 min	Ant-1 2	AV Disc
Every Sat	11:30 pm	1 hr 30 min	Ant-1 4-1	VCR

Figure 16. Record List screen

TV Guide On Screen® and the Record List

Programs scheduled through TV Guide On Screen do not appear on this record list. Refer to the separate *TV Guide On Screen® User's Guide* for information regarding scheduling recordings with TV Guide On Screen.

If there is a conflict between recordings scheduled through TV Guide On Screen and the Record List, the TV Guide On Screen recording takes priority.

Default Digital (Record) Device

This setting allows you to choose the default device to use when recording digital programs using the REC key from within ChannelView™ (page 60) or TV Guide On Screen®. Use this option only if you have more than one recording device set up in Netcommand.

A digital recording can be made on either a digital or analog device. For best playback quality, however, record digital programs on a digital recording device. Not that analog recordings can only be made on the one analog device connected to RECORD OUTPUT (usually a VCR) and are not affected by this setting.

If multiple devices were not connected and then added in the NetCommand setup, this setting will be unavailable (grayed out).

Analog Recordings

When you record a 16:9 digital channel to an analog VCR or recording device, there is a mismatch between the picture shape of the 16:9 ratio of the source and the narrower 4:3 ratio of the analog recorder.

- For anamorphic playback on this widescreen TV, choose the anamorphic picture display and ensure that the TV screen format is set to standard (see the section on TV formats in this Owner's Guide).
- For cropped playback on an older style 4:3 TV, choose the cropped display to remove the top and bottom sections. This setting does not affect recording from analog devices, analog channels, or 4:3 digital channels.

Setting Up Analog Recordings with TV Guide On Screen®

When setting up a recording using TV Guide On Screen, note that:

- You must select the desired recording device in the TV Guide On Screen Record Options menu.
- Analog programs can only be recorded to an analog recording device, such as a VCR.
- Analog programs cannot be recorded to digital devices such as A/V discs or DVCRs.
- The destination recording device for analog programs must be the analog device connected to the TV's RECORD OUTPUT jacks.

IMPORTANT

When setting up analog recordings in TV Guide On Screen, you must set the destination recording device as the analog device connected to the TV's RECORD OUTPUT jacks.

Channel Menu

Channel

Figure 17



Figure 17. Channel Menu

Antenna

Select the antenna for the channels you want to edit. You can select Ant-1 (main) or Ant-2 (Aux).

Prefer Digital

When a memorized channel number is available as both analog and digital, a check mark in the Prefer Digital box causes digital channels to be displayed and analog channels to be hidden (when using CH ▲ or ▼). Remove the check mark to show both analog and digital choices. This option is not available when TV Guide On Screen® is enabled.

Channel

Channels can be changed in three ways:

- Press ADJUST ▲ or ▼ to select the channel.
- Pressing CH ▲ or ▼ to select channels already in memory.
- Enter the number directly. Channel numbers can be one part, analog or digital (up to the number 16383), or two part for digital channels (these use a separator). For a two-part digital channel, press SUB/CANCEL on the remote to enter a separator after the first, second or third number, depending on the broadcaster's channel information.

For digital channels, when the broadcaster has sent a virtual channel number, the virtual channel number is shown in the text box and the original digital channel is shown below on-screen, as a reference.

Memory

After the available channels have been memorized with Memorize Channels on the Setup menu, weaker channels can be added or unwanted channels can also be deleted. Press CH ▲ or ▼ on the remote control to see the channels in memory. Press ADJUST ▲ or ▼ to select Added or Deleted for the channel shown in the Channel number box.

Name

Analog channels shown on Antenna-1 or Antenna-2 can be named (up to four characters). After you enter a name, it will appear on the TV screen, next to the channel number.

1. Press ADJUST ▲ or ▼ to select each letter.
2. Press ENTER to set the letter and move to the next letter position.
3. Press CANCEL to move back one position.

Digital channels are automatically named if the broadcaster sends the information.

Channel Menu, continued

SQV (SuperQuickView™)

Using The Menu Screen

Figure 17

SQV (SuperQuickView™) allows you to put together lists of your favorite channels from Antenna 1 and Antenna 2. You can store channels in any of the 9 different SQV memory banks. You can also store the same channel in multiple memory banks. Once you have added a channel to an SQV memory, “SQV” and the memory bank number will appear under the tuned channel number on the TV screen.

Adding SQV Channels

1. Select the channel using the “Channel” option box or press CH ▲ or ▼.
2. Highlight the bank (SQV1-SQV9).
3. Press ENTER to check mark the selected SQV memory bank.
4. Repeat for additional channels or banks.

Removing SQV Channels

1. Highlight the box for the SQV bank number.
2. Press ENTER to remove the check mark.

SQV (SuperQuickView™)

Using The Remote Control

Viewing and changing SQV banks using the remote control:

1. Press the SQV button.
2. To change memory banks, press a number button within 5 seconds of pressing the SQV button.
3. Press the SQV button repeatedly to cycle through the channels available in that bank.

Adding SQV channels using the remote control:

1. Press CH ▲, ▼, or number buttons to select the channel you want to add to the current SQV memory bank.
2. Press and hold the SQV button for about 2 seconds. When “SQV” and the memory bank number appear under the channel number, the channel has successfully been added.

Removing SQV channels using the remote control:

1. Press the SQV button and then the memory bank number.
2. Press the SQV button repeatedly until you see the desired channel.
3. While the channel number and SQV indicator (with correct bank number) are still displayed on the screen, press the CANCEL button. If the CANCEL button is not pressed before the SQV indicator disappears automatically, the channel will not be removed.
4. When the SQV indicator disappears, the channel has successfully been removed only from that bank. “Other” banks remain unchanged.

Signal Strength

Displays the approximate signal strength of the currently tuned digital channel. Use this indicator to help you adjust the antenna direction for optimal signal strength. The higher the bar, the stronger the signal. Does not apply to analog channels.

You can change the tuned channel while in this menu so that you can see the effects of antenna adjustments. To change the channel, either:

- Highlight the channel box, press CH ▲ ▼ or ADJUST ▲ ▼ to display the desired channel number, and press ENTER.
- Enter the channel number on the remote control and press ENTER.

Captions Menu

Captions Menu

Figure 18

For analog channels, broadcasters can send either Standard or Text closed captioning. Standard Closed Captions follows the dialogue of the characters on screen and displays in a small section of the screen. Text Closed Captions often contain information such as weather or news and covers a large portion of the screen.

On digital channels, broadcasters can send up to six different captioning selections or can send analog captions the same as the analog station sends. Each TV station may broadcast only one or two types of captions or none at all. The TV cannot decode Closed Captions received on COMPONENT 1–3 or HDMI 1 or 2.



Figure 18. Captions Menu

Analog Captions

The TV can display one of the following captions for Analog sources:

- CC1, CC2, CC3, or CC4. (Standard closed captioning signals).
- Text1, Text2, Text3, or Text4. (Text closed captioning signals).
- On if mute. Closed captions when mute. When selected, the standard closed captioning signal (CC1) will turn on/off by pressing MUTE on the TV remote control.
- Off. No closed captions.

IMPORTANT

When analog text closed captioning is selected, a large black or gray box appears on your TV screen if no signal is broadcast.

Background

To make the analog closed captions easier to read, you can choose to display the background color as either black or gray behind the captions.

Digital Captions

The TV can display one of the following Captions for Digital sources:

- Captions 1-6. Sent by broadcaster.
- On if Mute. Closed captions when mute. When selected, the captioning signal (Caption 1) will turn on/off by pressing MUTE on the TV remote control.
- Off. No closed captions.

Note: For digital programs, if the broadcaster is sending only analog captions converted to digital, then the analog captions settings apply.

Appearance

Closed Captions provider selects the Default options when sending digital closed captions. You may select the Custom option to override and customize Closed Captions appearance. These settings do not apply to analog Closed Captioning converted to digital.

Digital Settings

Figure 19

Move the highlight to the Digital Settings icon and press ENTER. The Digital Settings menu allows you to customize the appearance of the closed captions sent by the broadcaster. Digital settings do not apply to analog closed captions converted to digital.

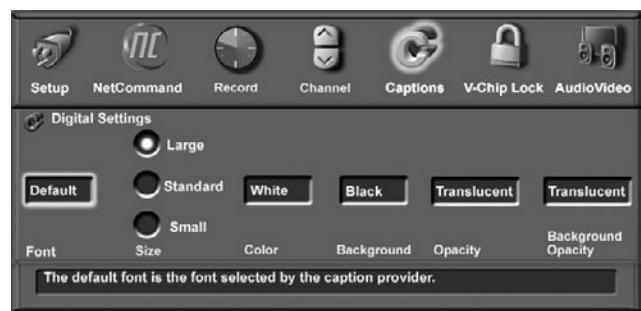

Figure 19. Closed Captions Menu Digital Settings

Captions Menu, continued

Fonts

You can customize the text of digital captions by selecting the font of your choice. The available font options are as follows:

- Default—Selected by the Closed Captions provider
- Font 1—Monospaced font with serifs
- Font 2—Proportionally spaced font with serifs
- Font 3—Monospaced font without serifs
- Font 4—Proportionally spaced without serifs
- Font 5—Casual font
- Font 6—Cursive font
- Font 7—Small Capitals font

Size

You can also customize the text of digital captions by selecting your desired size of font. Large is the recommended font size.

Color

You can customize the text of digital captions by selecting the font color. The available font colors are listed below. Text and background cannot be set to the same color.

White	Yellow
Black	Green
Magenta	Cyan
Red	Blue

Background

To make the digital closed captions easier to read, you can choose the background color. The available background colors are listed below. Text and background cannot be set to the same color.

White	Yellow
Black	Green
Magenta	Cyan
Red	Blue

Opacity (Font)

You can customize the visibility of your fonts using the following categories:

- Translucent—TV program is faintly visible behind the text
- Transparent—See-through text reveals the TV program
- Opaque—Solid color text; blocks the TV program
- Flashing—Text flashes at intervals

Background Opacity

You can customize the background for digital captions using the following categories:

- Translucent—TV program is dimly visible behind the background
- Transparent—See-through background reveals the TV program
- Opaque—Solid background; covers TV program
- Flashing—Background flashes at intervals

IMPORTANT

We recommend you use contrasting colors for captions and background. Black translucent background combined with a white font make an easy-to-read combination.

Use care when selecting custom colors. Your choice may change the legibility or readability of captions.

IMPORTANT

The content of captions is determined by the broadcaster. If your captions show strange characters, misspellings, or odd grammar, it is not a malfunction of the TV.

V-Chip Lock Menu

V-Chip Lock Menu Overview

Figure 20

The V-Chip Lock menu gives you access to three different types of TV locks. You must use a pass code to open this menu to enable/disable the lock options. The three different types of locks available are:

- **V-Chip**
Lets you restrict access to programming based on program-rating signals sent by the broadcaster. You can also set the time of day for these restrictions to be in effect.
- **Lock by Time**
Lets you restrict all TV viewing by time of day.
- **Front Button Lock**
Lets you disable the controls on the front of the TV. Use this option if there are small children near the TV who may be tempted to press the front-panel buttons.

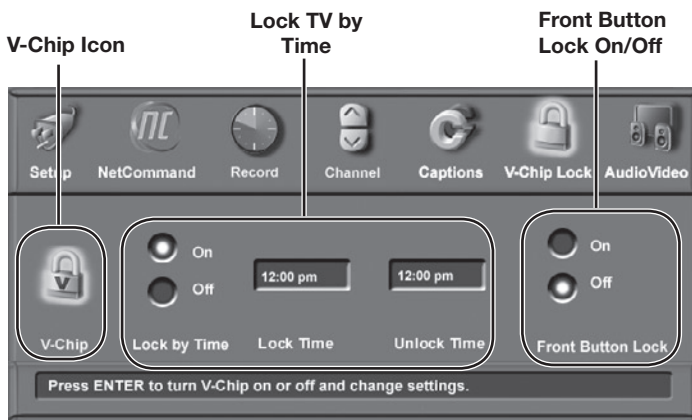

Figure 20. V-Chip Lock menu

Setting a Pass Code

You are prompted to enter a pass code whenever you select V-Chip Lock on the menu or press the V-CHIP key on the remote control. To set a pass code for the first time:

1. Do one of the following:
 - Press V-CHIP on the remote control.
 - Press TV MENU, highlight V-Chip Lock, then press ENTER.A screen prompting you for a pass code displays.
2. Input a four-digit pass code using the number keys on the remote control.
 - Press CANCEL to delete a number and move back one space.
 - Press MENU or HOME to exit without setting a pass code.
3. Press ENTER to confirm the pass code just input.

To reset the pass code, see the procedure in Appendix C.

IMPORTANT

If you forget your four-digit pass code, see Appendix C.

V-Chip Menu

Figure 21

The V-Chip menu allows you to:

- Turn the V-Chip Lock on or off
- Change the permitted V-Chip rating level
- Set the time of day to enforce rating restrictions

The TV comes from the factory with pre-set V-Chip ratings and with the V-Chip Lock turned off. The preset ratings are TV-PG (TV rating) and PG (movie rating). If you turn on the V-Chip, these presets will allow only programs rated TV-PG/PG or lower. You can turn on V-Chip from this menu or by using the V-CHIP button on the remote control. Use the V-Chip menu to change the permitted rating levels.

After changing channels or devices, there may be a delay of up to five seconds before the V-Chip lock takes effect.



Figure 21. V-Chip menu

Setting V-Chip Options

1. Highlight the V-Chip icon  on the V-Chip Lock menu (figure 20) and press ENTER to open the V-Chip menu (figure 21).
2. Press ADJUST ▲ or ▼ to select On or Off.
3. If you selected On, press ADJUST ► to move to the TV Rating box.
4. Press ADJUST ▲ or ▼ to select the TV rating level you want to allow.
5. Press ADJUST ► to move to the TV content categories.
 - Press ADJUST ▲ or ▼ to move between categories.
 - Press ENTER to add check marks to the TV content categories you want to block.

V-Chip Lock Menu, continued

6. Press ADJUST ► to move to the Programs Not Rated box. Press ENTER to add or delete a check mark to allow or block programs that are not rated.

NOTE: Use care when choosing to block unrated programming. News programs and emergency bulletins carry the “None” or “NR” (Not Rated) V-Chip rating, and these are blocked with this option active.

7. Press ADJUST ► to move to the Movie Rating box. Press ADJUST ▲ or ▼ to select the movie rating level you want to allow. See the next page for detailed information on rating guidelines.
8. To set the time of day when these restrictions will be in effect, press ADJUST ► to move to the Start box. To set the time:
 - a. With the highlight on the hour number, press ADJUST ▲ or ▼ repeatedly to change the hour. You can also just press and hold to change the hour.
 - b. Press ENTER to move the highlight to the minutes.
 - c. With the highlight on the minutes number, press ADJUST ▲ or ▼ repeatedly to change the minutes. Just press and hold to move quickly through the numbers.
 - d. Press ENTER to move the highlight to the am/pm option. Press ADJUST ▲ or ▼ to make a selection.
9. Press TV MENU to save the settings and close the menu.

NOTE: To make the V-Chip restrictions active twenty-four hours a day, set the V-Chip Start and Stop to the same time.

The V-CHIP Button

Press the V-CHIP button on the remote control to turn the V-Chip lock on and off without going through the menu. A screen will appear prompting you for your pass code. To change V-Chip settings, you must open the V-Chip Lock Menu and then open the V-Chip menu.

Lock by Time

Lock by Time allows you to entirely block use of the TV during specified hours. During the lock time, you must use your pass code to view the TV. To lock the TV by time:

1. Press ADJUST ▲ or ▼ to select On or Off for Lock by Time.
2. Press ADJUST ► to move to the Lock Time box.
 - a. With the highlight on the hour number, press ADJUST ▲ or ▼ repeatedly to change the hour. You can also just press and hold to change the hour.
 - b. Press ENTER to move the highlight to the minutes.
 - c. With the highlight on the minutes number, press ADJUST ▲ or ▼ repeatedly to change the minutes. Just press and hold to move quickly through the numbers.
 - d. Press ENTER to move the highlight to the am/pm option. Press ADJUST ▲ or ▼ to make a selection.

To make Lock by Time active 24 hours a day, set the Lock and Unlock Times to the same time.

Front Button Lock

Figure 20

Front Button Lock lets you disable controls on the front panel to prevent inadvertent changes to TV settings. Select On to disable the buttons and select Off to restore their operation.

To disable the front button lock, press and hold the MENU button on the front panel for more than eight seconds. If the TV is on, a message will display confirming release of the Front Button Lock.

Bypassing V-Chip Lock and Lock by Time

If you try to watch blocked programming, a notice appears prompting you for a pass code. To use the TV:

- Input your four-digit pass code and press ENTER.
- Change to a channel airing an allowed program or change to another device.

If you try to use the TV when it is locked by time, a similar screen appears, prompting you for your pass code.

To reactivate the V-Chip lock or TV lock by time after using the pass code, power the TV off and then on.

V-Chip Ratings

V-Chip Signal Information

When provided by the broadcaster, V-Chip ratings can be used to control which programs can be viewed or will be blocked. When V-Chip ratings are sent, you will see the ratings when you change the channel or when you press the INFO button on the remote control. Both TV and Movie ratings will display. TV ratings apply to programs and movies developed for TV and may have supplemental blocking by content categories. Movie ratings use MPAA ratings for movies released in theaters.

V-CHIP EXCEPTIONS:

1. V-Chip is not effective for programs viewed on devices connected to component inputs or HDMI.
2. Videotapes, laser discs and DVDs may not contain V-Chip rating signals. If they don't contain the V-Chip signal, V-Chip cannot block the program or movie.
3. Broadcasters are not currently required to include V-Chip rating signals at this time. If the broadcaster does not include the V-Chip rating signal, V-Chip cannot block the program.

TV Ratings:

Used with TV programs and Made-for-TV movies.

- TV-Y** Youth, for children under the age of 7.
- TV-Y7** Youth, 7 years old and older.
- TV-G** General Audience. For the entire family to view.
- TV-PG** Parental Guidance. Parental Guidance is recommended, may not be suitable for some children.
- TV-14** Adolescent 14 years old and older. Not recommended for children under the age of 14.
- TV-MA** Mature Audience. For adults only.

TV Rating	FV	D	L	S	V
TV-Y					
TV-Y7	X				
TV-PG		X	X	X	X
TV-14		X	X	X	X
TV-MA			X	X	X

Content Categories:

Used in association with the TV ratings above.

- FV** Fantasy Violence—applies to TV-Y7 only.
- D** Sexual Dialog—applies in different degrees to TV-PG and TV-14.
- L** Adult Language—applies in different degrees to TV-PG, TV-14, and TV-MA.
- S** Sexual Situations—applies in different degrees to TV-PG, TV-14, and TV-MA.
- V** Violence (graphic or realistic)—applies in different degrees to TV-PG, TV-14, and TV-MA.

When you select a TV rating, you are selecting the least-restrictive program level that can be viewed. For example, if you select TV-PG, you are allowing programs rated TV-Y, TV-Y7, TV-G and TV-PG to be seen and blocking programs rated TV-14 and TV-MA. When you select a TV Content category, you will block all TV programs that have the same content category listing. For example, if you select to block V (Violence) at the TV-14 level, you will also block any program that has the V category listing at the TV-PG rating level as well.

Movie Ratings:

Used with theater released movies and direct-to-video movies.

- G** General Audience—Designed for the entire family to view.
- PG** Parental Guidance—Parental Guidance is recommended, may not be suitable for some children.
- PG-13** Parental Guidance 13 years old and older—Not recommended for children under the age of 13.
- R** Restricted—Restricted in the theater to 17 years old and older unless accompanied by an adult.
- NC-17** No Children 17 or under—Restricted in theater to 18 years old and older.
- X** Adult—Designed for and restricted in the theater to adult audiences only.

When you select a movie rating, you are selecting the least-restrictive program level that can be viewed. For example, if you select a movie rating of PG-13, you are allowing movies rated G, PG and PG-13 to be seen and blocking movies rated R, NC-17, and X.

Programs Not Rated: Used for programs that are not rated, such as news, sports, weather, emergency bulletins, or movies prior to or without MPAA Ratings. This does not include programs without V-Chip signals.

IMPORTANT

If you elect to block programs that carry the V-Chip rating "Programs Not Rated," you may block news or emergency bulletins, when "None" or "NR" Not Rated V-Chip rating is included. Use care when blocking programming that is not rated.

Audio/Video Menu

Audio/Video

Figure 23



Figure 23. Audio/Video Menu

A/V Memory Reset

A/V Memory Reset allows you to reset a specific device's A/V settings to the original factory settings. Select the device name in the box and press ENTER. Note that the audio settings of Balance, Listen to, and Language are not associated with any specific device and are unaffected by A/V Memory Reset. To reset all A/V settings at once, including these three, perform an A/V Reset using the front-panel buttons.

Settings

Each device has its own A/V memory. Select the device in A/V Memory Reset, then select Audio or Video to adjust the device's individual settings. Press ENTER, and the menu is removed and the individual settings are displayed.

Use ADJUST ▲ or ▼ to select the individual settings to be adjusted. Use ADJUST ◀ or ▶ to make the adjustment. For descriptions of the individual A/V settings see A/V Setting Descriptions, pages 80 and 81.

Video Mute

Video Mute lets you display a blue background when no signal is being received on Inputs 1–3, COMPONENT 1–3, and HDMI 1 and 2.

Film Mode

Auto is the default setting. With Auto selected, the TV automatically detects and applies film-decoding correction for images that originated on 24-frame-per-second film cameras and were then converted to 30-frame-per-second video for broadcast. Try the Off setting if the TV adds too many jagged edges to the images.

When the original video was filmed on 30-frame-per-second cameras, the Auto setting automatically applies video decoding, the same as used with the Off setting.

Film Mode is not effective for high-definition signals.

TV Speakers

When an A/V receiver has not been set up in NetCommand, this selection will turn the TV's internal speakers on or off. You may select Off when sending the sound through a separate stereo system or surround sound A/V receiver.

This option is unavailable (grayed out) when NetCommand® is enabled and you have selected the A/V receiver icon from the Device Selection menu. In that case, NetCommand automatically turns the TV speakers off. See the NetCommand information for further instructions.

Note: To prevent damage from a sudden increase in volume, make sure the TV volume is set to low before setting speakers to On.

Using the AUDIO or VIDEO Button on the Remote Control

To adjust individual Audio or Video settings directly with the remote control:

1. Press AUDIO or VIDEO to cycle through the available settings.
2. Press ADJUST ◀ or ▶ to adjust the setting. After five seconds of inactivity, the setting display will disappear.

Audio Settings

NOTE: The effects of the audio settings of Bass, Treble, Balance and Surround affect the sound heard through the TV speakers only.

Analog and Digital Audio Settings

A slider displays on screen for most settings. When the slider is displayed, it has a numeric value, so that 63 is the maximum, 31 is the mid-point, and 0 is the minimum.

◇ Bass

Enhances or reduces low-pitched sound.

◇ Treble

Enhances or reduces high-pitched sound.

◇ Balance

Adjusts the level of sound between the left and right speakers.

◇ Surround

Creates simulated stereo and surround effects through the TV speakers. Your choices are:

- Off: No surround effects.
- Simulated Stereo: Your TV will create a simulated stereo effect when watching a non-stereo program.
- Surround Sound: Your TV will create a simulated surround effect when watching a stereo program.

◇ Level Sound

Turn On or Off to automatically equalize the volume level when there are significant sound-level differences between program segments, e.g., between regular programming and commercials. To receive the best fidelity with music programs, turn this setting to Off. When connecting to an A/V receiver, set level sound to OFF and turn the TV speakers off to send full dynamics to the A/V receiver.

Analog-Only Audio Settings

You can set analog-only audio settings while viewing either analog or digital sources, but the settings affect broadcast or recorded analog content.

◇ Listen to

Determines how your TV receives a broadcast audio signal and plays the sound you hear.

Your choices are:

- Stereo: Default setting. The TV plays stereo broadcasts in stereo and mono broadcasts in mono. The word “Stereo” is displayed when you tune to a channel broadcasting in stereo.
- SAP (Second Audio Program): Additional monaural sound track that you cannot hear during normal TV viewing. The SAP signal might

be related to the program you are watching, (such as a sound track in a foreign language), or it might be unrelated (such as a weather report). If an SAP signal is broadcast, the letters “SAP” are displayed when you tune to the channel.

- Mono: Reduces background noise. Use when receiving a weak stereo audio signal. All audio is played mono with this setting.

Listen to is not available for devices connected to the TV Inputs, component inputs, or 1394 devices.

Digital-Only Audio Settings

You can set digital-only audio settings while viewing either analog or digital sources, but the settings affect only broadcast or recorded digital content.

◇ Language

Determines what possible language you can hear. Your choices are:

English	Portuguese
French	Spanish
German	Other
Italian	

IEEE 1394 Amplifier Settings

◇ Balance

Adjusts the level of sound between the left and right speakers. The slider range is 0–254, with 127 at the center.

◇ Loudness

Set to On to make the audio level more uniform.

◇ Preset

Select the mode that matches the audio source. Your choices are:

- Off
- Classical Music
- Jazz
- Movie
- Rock
- Speech

◇ Equalizer

Equalize the sound.

Video Settings

Video Settings

Press the VIDEO key repeatedly to cycle through the Video options to the one you want to change. Use ADJUST ◀ ▶ to change settings.

Bright/Natural Modes

Bright and Natural modes are available for some settings and allow you to optimize the image for a brighter (daytime) or dimmer (nighttime) viewing environment. To do this, your TV remembers two independent Contrast, Brightness, and Color Temperature settings, one for each of the two modes. Whenever you change settings for Contrast, Brightness, or Color Temperature, first check which of the two modes (Bright/Natural) is active.

- ◇ **Contrast** (Bright/Natural)
Provides a slider to adjust the white-to-black level. Low contrast shows a variety of shades in darker images, while high contrast shows darker images more uniformly black and makes colors appear more vibrant. In most home lighting situations, a medium contrast looks best. High contrast is good for brightly lit environments.
- ◇ **Brightness** (Bright/Natural)
Provides a slider to adjust the overall brightness of the picture.
- ◇ **Color**
Provides a slider to adjust the color intensity.
- ◇ **Tint**
Provides a slider to adjust the ratio of red to green.
- ◇ **Sharpness**
Provides a slider to adjust the detail and clarity.
- ◇ **Color Temp** (Bright/Natural)
Allows you to adjust how white images are displayed. Your choices are:
 - Low: White images will have a warm cast to them. This adjustment is an average and can vary due to ambient room lighting, video scene brightness, and the TV's age. Natural/Color Temp at the low setting displays video at the 6500K industry standard for NTSC pictures.
 - High: White images will have a cool cast to them. This setting may provide the most realistic picture under bright lighting.
- ◇ **PerfectColor™**
Adjusts any or all of six colors (Magenta, Red, Yellow, Green, Cyan and Blue) to create color balance. When you select PerfectColor and press ENTER, you can adjust the colors automatically or manually (individually).

Individual sliders for each color are displayed. Highlighted text shows which slider you are

adjusting. Each TV input or device has a memory for PerfectColor. While using the PerfectColor option, press CANCEL if you want to reset the colors to the default settings.

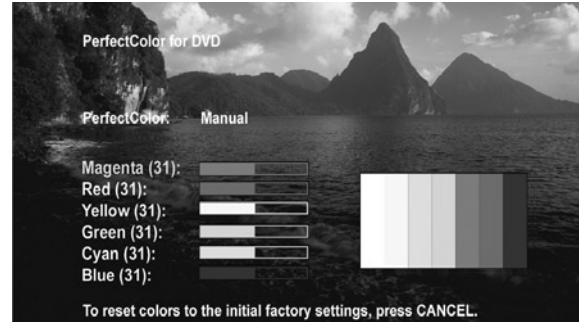

- ◇ **Video Noise**
Use to reduce minor noise (graininess) in the broadcast received on Ant-1 and Ant-2, Inputs 1–3, Component 1–3, and HDMI 1 and 2. Use the Standard setting with good-quality signals.
NOTE: A slider displays on screen for most settings. When the slider is displayed, it represents numeric values, with 63 as the maximum, 31 as the mid-point, and 0 as the minimum.
- ◇ **DeepField™ Imager**
When On is selected, the black levels are dynamically enhanced in portions of the screen to provide strong contrast with detail over mixed screen content. When Off is selected, the entire screen adjusts the contrast the same. When Demo is selected, a split screen picture appears and you can see how the picture will look when DeepField Imager is On (right side) or when it is Off (left side).
- ◇ **SharpEdge™**
When ON is selected, special edge sharpness enhancements are applied to the vertical edges of images.

PC Video Settings

- ◇ **Auto Position.** Press ENTER to automatically center the position of the PC video.
- ◇ **HorizPosition (Horizontal Position).** Manually adjust the horizontal position of the PC. This selection overrides the Auto Position selection.
- ◇ **VertPosition (Vertical Position).** Manually adjust the vertical position of the PC. This selection overrides the Auto Position selection.
- ◇ **Fine Detail.** Manually adjust the picture quality of the PC. This selection overrides the Auto Position selection.

Additional Features

MediaCommand™ and Memory Card Playback	84
Operation of PIP and POP	86
TV Display Formats.	87
PC Viewing	89
PC Display Formats	90

MediaCommand™ and Memory Card Playback

Warning: Some memory cards available on the market are not properly certified to follow the card type specifications noted below and cannot be used by the card reader. If you experience problems with the reading of your file, please transfer your files to a properly certified card.

Memory Card Slots

Inserting a memory card

1. Insert a card into a matching card slot on the front of the TV. Be sure to use the correct card slot. Card 1 accepts SmartMedia™. Card 2 accepts MultiMediaCard™ and SD Media Card. Card 3 accepts CompactFlash® and MicroDrive®. Card 4 accepts MEMORY STICK™ and Memory Stick Pro. Cards up to 1 GB, with a file format of FAT 16 (block size = 1024 or 2048) are supported.

Normally the label side should be up, but if the card does not fit, try turning the card over and insert again. When properly inserted, the light next to the slot will light up.

2. Press DEVICE on the remote control to display the Device Selection Menu and then select the correct card slot from the list, using ADJUST ▲▼◀▶.
3. The Media Dialog box (figure 1) will automatically display. Use the AUDIO button to switch from JPEG Picture Slide show setup to MP3 or WMA7 Audio Playlist setup, or use the VIDEO button on the remote to switch from the MP3 or WMA Audio Playlist setup to JPEG Picture Slide show setup.

Don't pull the memory card out while it is playing.

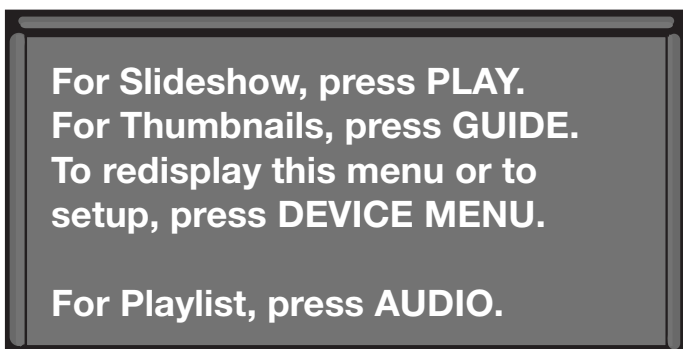

Figure 1. Media Dialog Box

4. On the remote control, press:
PLAY: to start the slide show or play audio.
GUIDE: to display the JPEG Thumbnail menu (Figure 2) or Audio track playlist (Figure 3)
DEVICE MENU: to display the Media Setup menu (Figure 4).

Remote Control Buttons for Controlling the Playback

For JPEG Picture Slide show:

- PLAY: begins or resumes slide show playback
PAUSE: pauses or resumes playback while in the automatic advance mode.
FF: skips to the next slide.
REW: returns to the previous slide.
FORMAT: single press rotates the slide 90°. Multiple presses continue to rotate the slide.
STOP: Stop slide show, return to memory card screen.

For MP3 or WMA Audio Playback

- PLAY: begins or resumes playlist playback.
PAUSE: pauses or resumes playback.
FF: skips to the first track/song.
REW: skips to the previous track/song.
STOP: Stop playback and returns to memory card screen.

Using the Picture Thumbnail Menu or Audio Playlist Menu

For JPEG Picture Thumbnail Menu:

Figure 2

1. Press GUIDE on the remote to display the JPEG picture Thumbnail menu.
2. Press ADJUST ▲▼◀▶ to move the highlight to different images (CH up/down will change pages of the Thumbnail menu). Use REW to go to the first slide and FF to go to the last slide on the page.
3. Press FORMAT to rotate the selected image 90° (pressing FORMAT four times will rotate the image completely around to the original position).
4. Press PLAY to begin playback of the Slide show from the selected image. The Thumbnail menu will be taken down.



Figure 2. JPEG Thumbnails

Media Command™ and Memory Card Playback, continued

For MP3 or WMA7 Playlist Menu:

Figure 3

1. Press GUIDE to display the Playlist menu.
2. Press ADJUST ▲ or ▼ to select different tracks (CH up/down will change pages of the Playlist). Use REW to go to the first track on the page and FF to go to the last track on the page.
3. Press PLAY to begin playback. The Playlist menu will be taken down. The song currently playing will be highlighted.



Figure 3. Audio Playlist

COMPATIBLE PICTURE OR AUDIO FILES:

For JPEG Pictures up to 1 GB:

1. Still images recorded on digital cameras using the Exchangeable Image File Format, version 2.1 (EXIF 2.1) standard for digital still cameras and Design Rules for Camera File Systems version 1.0 (DCF 1.0)

Some images opened and resaved on a computer may not play back or may not be able to display a picture in the thumbnail list because the computer program that opened and resaved the images changed the file to an incompatible format.

2. Standard digital images with a maximum size of 5 megapixels for each image, or 2560 x 1920 pixels. Pictures will be scaled to the TV display. Some pictures may be cropped to fit.
3. Full path file names can be no longer than 50 characters and must end in a .jpg extension. Not all 50 characters will display.

Images larger than 256MB can take a longer initial time to display.

For MP3 or WMA7 Audio files:

- Files recorded with sampling rates of 32 kHz, 44.1 kHz or 48 kHz.
- Files recorded with fixed bit rates
- File names with .mp3 or .wma extensions

NOTES

- During WMA7 audio playback, audio from the cards is sent to the A/V receiver as analog audio. Digital out is not available.
- Repetitive noise may be present when playing WMA digital audio files from memory files.

Media Setup Menu

Figure 4

Press DEVICE MENU at any time to display the Media Setup screen, where you can adjust the Slide show Display, Frequency, Interval or Playlist Frequency.

For JPEG Picture Slide Show Setup

- For JPEG picture slide show playback, select Automatic or Manual advance. For manual operation, press PLAY or ENTER on the remote control to advance each slide.
- For automatic advance, select the frequency or number of times to show the complete slide show, Once, Twice or Continuously.
- For automatic advance, select the interval time each slide is shown, for example, five seconds, or 30 seconds

For MP3 or WMA7 Audio Playlist Setup

- Select the frequency or number of times to play the complete playlist. Once, Twice or Continuously.

To exit, press DEVICE MENU on the remote control to redisplay the memory card screen.

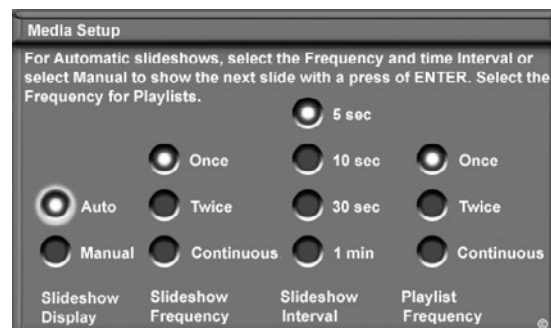

Figure 4. Media Setup Menu

IMPORTANT

JPEG images cannot be edited through the TV. Only name changes should be made on your PC to avoid file incompatibility problems.

MP3s must have at least 32-kHz sampling rate.

Operation of PIP and POP

You can display programs from analog channels, analog inputs, or analog devices as picture-in-picture (PIP) and picture-outside-picture (POP). The TV has a second analog tuner for non-scrambled analog channels received on ANT-1 and displays them as the PIP/POP sub-pictures. Digital channels and devices can be shown as the main picture but cannot be the sub-picture. PC screens can be viewed as the main picture with PIP.

Press PIP/POP to activate the PIP/POP option. With each press of the PIP/POP button on the TV remote control, (within seconds of each press), the PIP/POP cycles through the following display options:

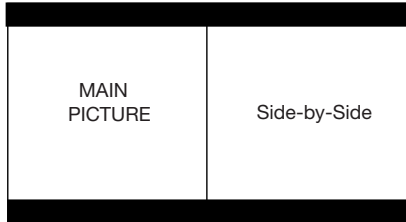

*Side-by-side pictures
(Not available when PC is source)*

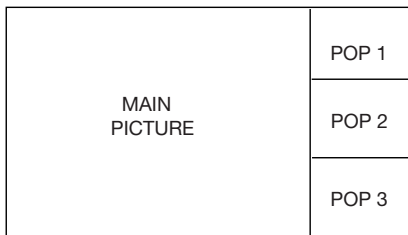

*3 POP
(Not available when PC is source)*

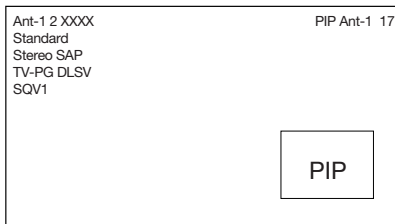

*PIP
(PC as main picture only)*

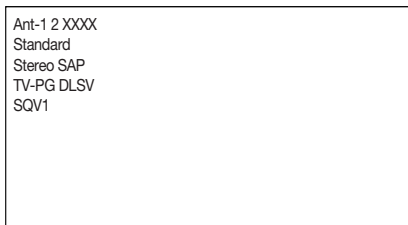

PIP off

To turn PIP/POP off, wait at least 10 seconds and then press PIP/POP. The next time you activate PIP/POP, the last-used PIP/POP option will be displayed.

Changing PIP/POP Device

When PIP is displayed, press PIP DEVICE to change the PIP picture source device. A menu similar to the Device Selection menu will be displayed.

Changing PIP/Side-by-Side Channels

Press PIP CH to scroll up and down through memorized channels on ANT-1 and ANT-2.

Exchanging Program Images

Press EXCH to exchange the main picture and the PIP/POP picture. Pictures from digital channels can only be shown as the main picture. PC images can only be the main picture. If you press EXCH while viewing images from a PC, the TV exchanges audio with the PIP but leaves the main image in place.

Moving a PIP Image

If no menus are on screen, press ADJUST ▲, ▼, ◀, or ▶ to move the PIP display anywhere on the main screen. When the main picture is from a PC, the PIP can be moved through four designated positions.

Automatic POP Switching

When automatic POP switching is active, the TV cycles through memorized analog channels on Ant-1 or Ant-2 or strobe pictures from other A/V components in the POP display. Press PAUSE to pause or restart automatic POP switching.

Selecting POP “Live” Image

Press ADJUST ▲▼◀▶ to select a different POP “live” image (automatic POP switching must be paused.)

Freezing the PIP and Side-by-Side Pictures

Press PAUSE to freeze the PIP and side-by-side images. Press PAUSE again to return to a “live” image.

IMPORTANT

- The side-by-side option cannot show the same channel or device on both sides.
- If ANT-1 or ANT-2 is the main picture, ANT-2 is not available as a PIP, POP, or side-by-side image.
- PIP/POP is not compatible with signals from memory cards.
- You can view only one HDMI input at a time with the PIP/POP or side-by-side feature.

TV Display Formats

This is a widescreen TV, also known as a 16:9 TV. This shape reflects the new types of images available from HDTV and many DVDs. There are still many older style narrow-screen images (called 4:3 aspect ratio) you will encounter. While there will never be a perfect solution for displaying a narrow image on a wide screen, Mitsubishi offers several display formats from which to choose.

Press **FORMAT** on the TV remote control to cycle through the available display formats. The last-used format for each device is used when you return to that device.

Note: Not all formats are available for PIP/POP. Side-by-Side is only available in Standard and Expand formats. Three POP is available in Standard format only. PC formats vary depending on the PC signal.

DVD Definitions:

Anamorphic (or Enhanced for Wide-Screen TV's):

These DVDs are recorded in a special way to properly show wide-screen images on 16:9 TV sets in the Standard format mode. This is the recommended choice.

Non-Anamorphic (or 4:3, 1:33:1, Letter box or Full Screen):

These DVDs are recorded for use with traditional shaped TVs. They may be full screen (4:3 or 1:33:1) which crops movies to fit the narrow TV, or Letter boxed, which adds black top and bottom bars.

This information may or may not be listed on the DVD case. Some DVDs support both types of recordings.

Signal Definitions

480i Signals: Traditional analog interlaced signals from or through ANT-1 and 2, INPUT 1 and 2, COMPONENT 1–3, and HDMI 1 and 2.

480p Signals: Progressive-scan analog DVD signals on COMPONENT inputs and HDMI 1 and 2.

720p & 1080i Signals: High-definition analog signals received through COMPONENT 1–3 and HDMI 1 and 2. These signals are always 16:9 (widescreen).

SD 4:3: Standard-definition narrow-screen format signals from digital channels and IEEE 1394 devices.

SD 16:9: Standard-definition widescreen format signals from digital channels and IEEE 1394 devices.

HD: High-definition wide-screen format signals from digital channels and IEEE-1394 devices. These signals are always 16:9 (widescreen).

Format Definitions

Standard: This is the full-screen format. HDTV signals use this format. This format is useful for displaying Anamorphic DVDs that have 1.78:1 or 1.85:1 aspect ratios. Anamorphic DVDs that have a 2.35:1 aspect ratio are displayed with black bars at the top and bottom, but show the entire image correctly. Narrow (4:3) images are stretched evenly from side to side. Available for all signals.

Expand: This enlarges the picture to fill the screen, cropping off some of the image at the top and bottom. This is useful for reducing the letter box top and bottom bars of non-anamorphic DVD images. Available for analog 480i, 480p and digital SD 4:3 signals only.

Zoom: This enlarges the picture, cropping off some of the image at each side and top and bottom. This is useful for removing or reducing the black top and bottom bars on anamorphic DVDs with a 2.35:1 aspect ratio. Available for analog 480i and 480p and SD 4:3 signals only.

Stretch: This format stretches a narrow (4:3) image across the screen; there is less stretch in the center than at the sides, however. This allows the entire narrow image to be displayed across the screen with less distortion than is seen in the Standard format. Available for analog 480i and 480p and SD 4:3 signals only.

Stretch Plus: Similar to stretch mode, but to minimize distortions on the side, the picture is expanded to crop off portions of the top and bottom. When no PIP is displayed, you can press **ADJUST** up or down to vertically adjust the position of the picture. Available for analog 480i and 480p and SD 4:3 signals only.

Narrow: This format displays narrow (4:3) images in their original shape, and adds stationary black side bars to fill the screen. Available for 480i, 480p and digital SD 4:3 signals only.

Wide Expand: Enlarges the picture, cropping some of the image on both sides. This Expand format is useful to remove or reduce black side bars added to narrow images that are converted to 16:9 signals for digital broadcast. Available for analog 1080i, 720p, digital SD 16:9 and digital HD signals.

TV Display Formats

ORIGINAL SIGNAL Non-anamorphic or SD 4:3

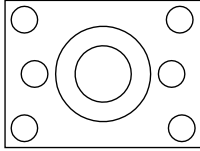

TV Display

Standard

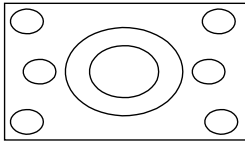

(not recommended, distorted)

Expand

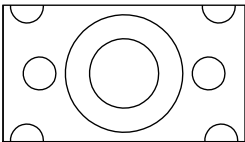

(recommended for letterboxed)

not available for
HD, SD 16:9 or
analog 720p, 1080i

Zoom

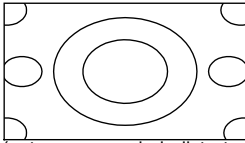

(not recommended, distorted)

not available for
HD, SD 16:9 or
analog 720p, 1080i

Stretch

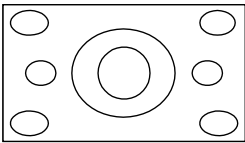

(recommended for standard broadcast)

not available for
HD, SD 16:9 or
analog 720p, 1080i

Stretch Plus

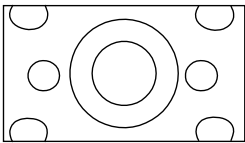

(recommended for standard broadcast)

not available for
HD, SD 16:9 or
analog 720p, 1080i

Narrow

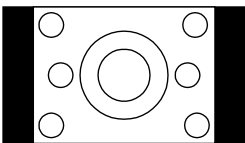

ORIGINAL SIGNAL Anamorphic DVD

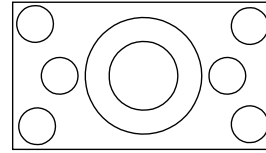

TV Display

Standard

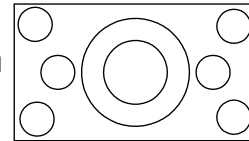

(recommended)

Expand

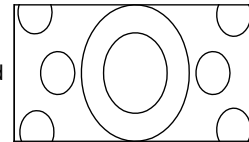

(not recommended, distorted)

not available for
HD, SD 16:9 or
analog 720p, 1080i

Zoom

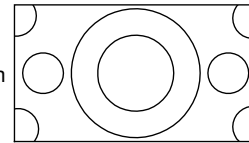

(recommended for anamorphic 2.35:1)

not available for
HD, SD 16:9 or
analog 720p, 1080i

Stretch

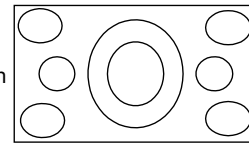

(not recommended, distorted)

not available for
HD, SD 16:9 or
analog 720p, 1080i

Stretch Plus

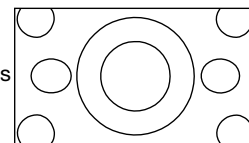

(not recommended, distorted)

not available for
HD, SD 16:9 or
analog 720p, 1080i

Narrow

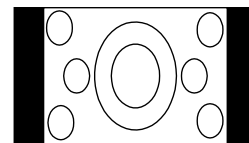

(not recommended, distorted)

not available for
HD, SD 16:9 or
analog 720p, 1080i

H
D
D
I
G
I
T
A
L

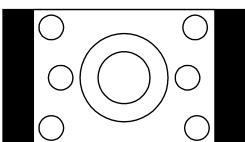

(with side bars in broadcast)

Standard
Original HD or SD
16:9, 720p or 1080i

Wide Expand

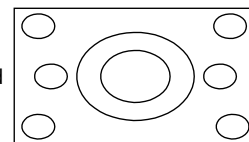

(recommended to remove side bars)

available only for
digital SD 16:9, HD,
analog 1080i or 720p

PC Viewing

Figure 1

To display your PC screen on the TV, first connect the PC to the HDMI 2 input on the TV's back panel (see Chapter 2). You must then activate the PC option in NetCommand. You can do this during initial NetCommand setup by selecting the PC option in the Device Setup screen. To do this at any time afterwards, use the NetCommand Add function. You will then be able to select the PC through the Device Selection Menu. For the correct screen resolution (pixels), use the PC's Control Panel settings as described below.

Your Mitsubishi TV can display resolutions from standard VGA (640 x 480) through XGA (1024 x 768) 60-Hz refresh rates only. See Appendix A in this book for more on screen resolutions. The instructions below are for most PCs.

1. In the PC's Start menu, select Settings.
2. Select Control Panel.
3. Select Display.
4. Choose the Settings tab.

5. Depending on your PC, adjust the resolution with either:
 - the Screen area slider.
 - the Screen Resolution slider

You may need to restart the PC for this change to take effect.

Hint: Whenever the TV is powered on, the lamp is in use, even if the TV screen appears dark. As a reminder that the TV is powered on and that time is being added to the lamp's elapsed hours, set the computer's screen saver to a pattern that will display after several minutes of inactivity.

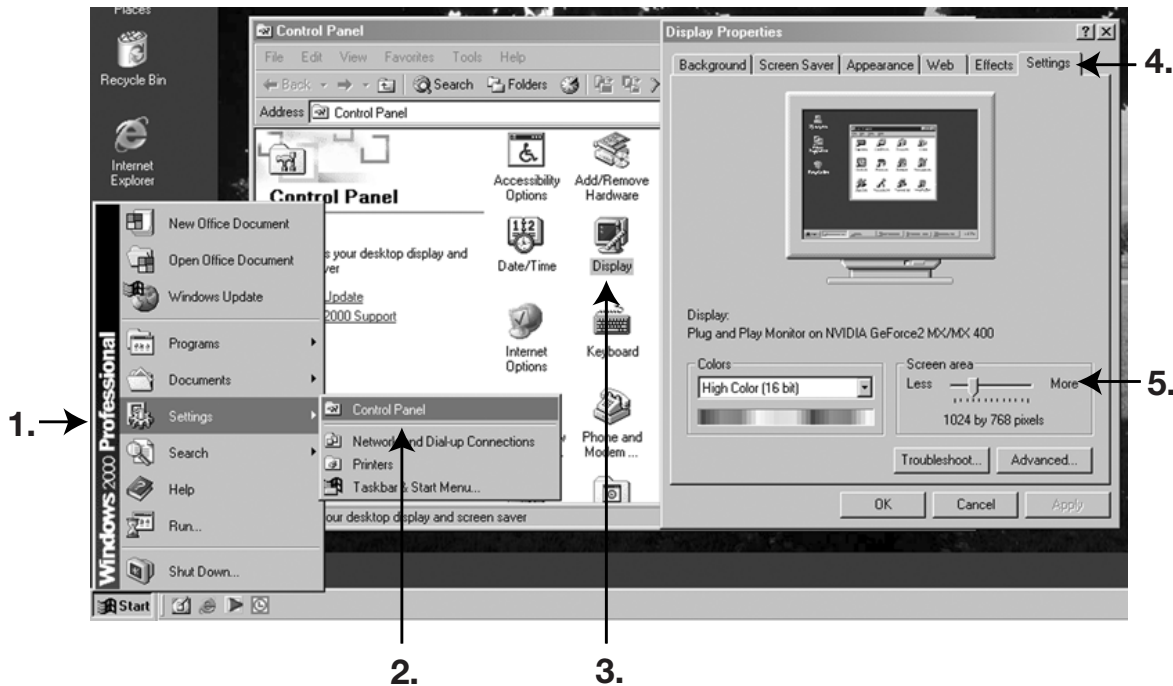
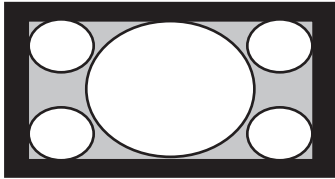
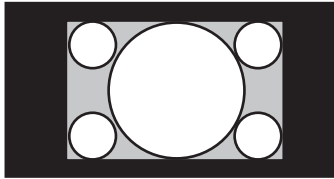
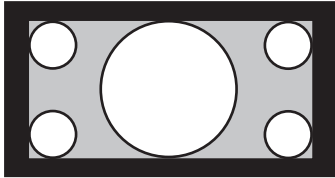
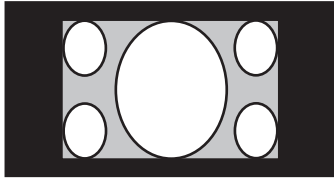
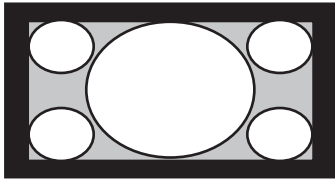
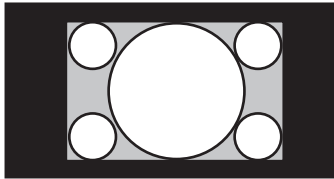
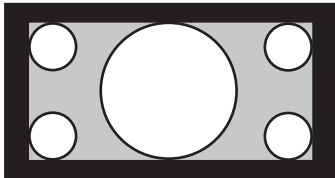
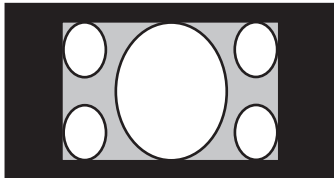
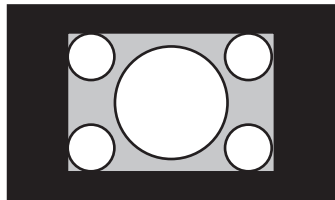
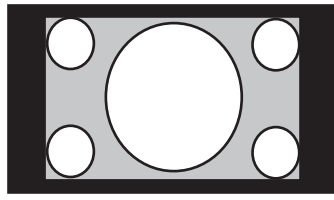
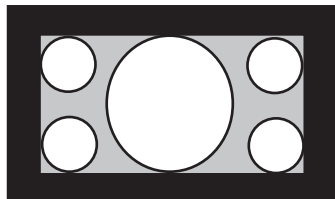
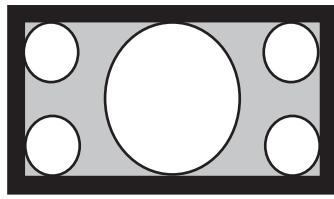

Figure 1. PC resolution XGA selection

PC Display Formats

Signal Format Original Pixel Counts	16 X 9 Standard	4 X 3 Standard
VGA 640 X 480	 1696 X 960	 1280 X 960
WVGA 848 X 480	 1696 X 960	 1280 X 960
SVGA 800 X 600	 1702 X 960	 1280 X 960
WSVGA 1064 X 600	 1702 X 960	 1280 X 960

Signal Format Original Pixel Counts	Standard	Zoom
XGA 1024 X 768	 1024 X 768	 1280 X 960
PC720p 1280 X 720	 1280 X 720	 1706 X 960

Chapter . . .

7

Troubleshooting

General TV Operation		
	Symptom	Suggested Solution
1.	The TV remote control does not work.	<ul style="list-style-type: none"> • Check that the batteries are installed correctly. • Check that the selected switch is set to "TV." • Be no more than 20 feet from the TV when using the remote control. • Program the remote control to operate the TV (Appendix D).
2.	The TV takes several seconds to respond.	<ul style="list-style-type: none"> • It is normal for digital channels to take longer to tune in. • Press ENTER after a channel number to avoid delays. • Use a 4-digit number for an over-the-air digital channel. • Use a 6-digit number for digital cable channels (your cable service must be able to recognize 6-digit channel numbers).
3.	Cable provider needs information to start CableCARD™ service.	On the remote control, press TV MENU and then enter the numbers 999 to display the Host ID and CableCARD™ ID information.
4.	You cannot access a channel.	<ul style="list-style-type: none"> • Use number keys instead of CHANNEL up/down. • Be sure the channel you want to view is in memory. See page 67. • Check that the TV is turned to the correct device or antenna for that channel by pressing the DEVICE button. • Make sure the V-Chip lock is off. • If you cannot tune to a virtual digital channel even though the TV has already memorized digital channels, tune to the channel number actually being used by the broadcaster. The virtual channel will then be automatically added to memory.
5.	On-screen displays appear each time you change a function.	This is part of normal TV operation.
6.	You cannot program the TV to turn on automatically (timer function)	<ul style="list-style-type: none"> • The TV may be locked. • The clock may not be set. • A time-delayed recording may have started.
7.	You have forgotten your V-Chip pass code.	See Appendix C, Bypassing the V-Chip Lock.
8.	V-Chip is not working.	<ul style="list-style-type: none"> • Make sure that V-Chip is On. • If V-Chip Hours are currently set to disable the V-Chip lock, the V-Chip will not block programming.
9.	The TV will not turn on after being plugged in.	If green light on front panel is blinking, wait for at least one minute for the light to turn off, then press Power again.
10.	TV functions do not respond to the remote control or to front panel control and TV will not power off.	Use the System Reset button .
11.	TV turned itself off and the light on the front panel started to blink.	<ul style="list-style-type: none"> • Momentary power fluctuation caused the TV to turn off to prevent damage. Wait for the green light to stop flashing and turn On again. • If the TV does not stay turned On, use the System Reset button. If this happens frequently, obtain an AC line power conditioner/surge protector. • An unusual digital signal may have been received, triggering a protection circuit. Wait for the light to stop flashing and turn TV on.
12.	Name options not available for some channels.	Only memorized analog channels can be named.
13.	When a device is selected from the Device Selection menu, the screen is blue (no signal source).	<ul style="list-style-type: none"> • Make sure the selected device is turned on. • From the Edit NetCommand® menu select Review setting. Verify that the devices are physically connected to the TV inputs as listed. If they are not, either change the physical connections on the back panel, or select the Change setting on the Edit NetCommand menu to change the TV NetCommand's settings for the connection. • Begin play of the VCR.

General TV Operation		
	Symptom	Suggested Solution
14.	A device does not respond to button presses from the remote.	<ul style="list-style-type: none"> • Remote has not been set up for NetCommand® use. • The incorrect manufacturer was selected during setup. Select the Change setting from the Setup menu and then the device to display the manufacturer selection. Change if necessary. • The device is not supported and keys have not been learned. • The requested function is not supported by NetCommand. Verify that the function is supported or keys are learned. • The IR emitter is incorrectly placed. Make sure the IR emitter is facing the IR sensor in the device. • The IR emitter is not plugged into the IR emitter Output NetCommand. • The IR emitter is facing the TV screen, causing double signals. Be sure that the IR emitter cannot send to the TV.
15.	The TV Speaker icon or A/V Receiver icon is grayed out and not selectable.	Select the Change setting from the Edit NetCommand menu, and then select the device (for example VCR). Once the Connection screen is displayed, check if the audio check box is selected for the TV input and/or AVR input.
16.	Devices are grayed out in the Device Selection menu or the PIP Selection menu.	<ul style="list-style-type: none"> • A recording is in progress. Cancel the recording to select the device. • Digital channels, digital devices, memory cards, and PCs cannot display in the PIP.
17.	Cannot see the A/V Receiver menu.	The A/V Receiver is not connected to any input of the TV. To check the A/V Receiver menu, temporarily plug into an unused input of the TV. Then select Review from the Setup Menu, turn the input On to view the A/V Receiver menu.
18.	The REC button is not working, or, on the Transport menu, the record key is grayed out and not available.	<ul style="list-style-type: none"> • The device, such as a DVD player, does not support recording. • Recordings cannot be initiated from the Transport menu when using an IEEE 1394 device. Press REC instead. The Record menu displays allowing setup of a recording.
19.	When ChannelView™ list is displayed, information appears incomplete	Available information is sent from the broadcaster or cable provider. No other data is available.
20.	Program to be recorded was correctly selected from ChannelView, however, incorrect program was recorded.	The broadcaster supplied program information that was incorrect and/or was changed after a recording was added to the Record List.
21.	Incomplete ChannelView program recorded.	Recording device may lack sufficient blank space to make a full recording.
22.	ChannelView program recording failed.	<ul style="list-style-type: none"> • Connection and compatibility issues with IEEE 1394 (FireWire®) digital devices. This may include too many Firewire devices in use at one time, or the recording device not understanding the record command. • Television lost power long enough to lose current clock time. • Analog VCR power was left off.
23.	TV is not responding after pulling out a memory card during playback.	Press STOP or wait until playback is complete before removing memory card.
24.	TV can't play or stop a memory card.	<ul style="list-style-type: none"> • NetCommand was not set up. Without NetCommand enabled, you can only use ENTER to play and CANCEL on the TV remote to control the memory cards. See Appendix D for programming the remote control. • Turn the TV off and then back on.
25.	Can't see a thumbnail picture in the JPEG menu, or can't see a track/song name in the Playlist menu.	File does not meet file standards for playback.

General TV Operation		
	Symptom	Suggested Solution
26.	The message "Lamp will soon exceed..." keeps displaying after the lamp has been replaced.	Reset the lamp reminder in the setup menu.
27.	NetCommand unable to learn specific device keys.	<ul style="list-style-type: none"> • Device does not use IR format for remote control signal. ITT and RF formats cannot be learned. • Room lighting may affect the signal. Have the remotes very close (6 inches or less) to the TV during Learning. • If using a Mitsubishi remote control, make sure slide switch is not set to TV position. • Some, but not all, device key functions can be learned by NetCommand. For example, POWER and PLAY may be learned, but other functions may not • The signal from the remote control may not be strong enough. Insert fresh batteries and try Learning again.

Picture		
	Symptom	Suggested Solution
1.	PIP does not display a picture.	<ul style="list-style-type: none"> • Make sure the V-Chip lock is off. • Not all inputs can be displayed as a PIP.
2.	Digital channels do not appear in PIP.	Normal PIP operation.
3.	There is a large black or gray rectangle on the screen.	The TV's analog closed captioning has been set to "text" mode in the Captions menu. Turn off because there is no text information being broadcast.
4.	You cannot see a picture when playing a VHS tape.	<ul style="list-style-type: none"> • Display the Device Selection menu and select the correct VCR. • Check your VCR's owner's guide for further troubleshooting.
5.	When viewing a stopped VCR, white lines are rolling on the screen.	<ul style="list-style-type: none"> • Turn off video mute for the VCR. • Begin playing the tape. • Change the VCR input to the antenna input.
6.	Screen is black when trying to view digital channels or IEEE 1394 device.	The PerfectColor™ color balance has been incorrectly set. Press VIDEO repeatedly until you see the PerfectColor option and press ENTER.
7.	A program recorded on your widescreen TV is distorted when played on a 4:3 TV.	TV was set to Anamorphic when program was recorded. Record programs in Cropped mode if playing back on a 4:3 TV. Open the Record menu and select Cropped before making such a recording.
8.	Cannot see a picture from a DV Camcorder.	DV formatting was not detected during automatic discovery, so you must specify it manually. Open the Edit NetCommand screen, select Change, then select the camcorder, Add, and in the Name for 1394 Device screen, check mark the DV box.
9.	DVCR analog/digital problems.	If the tape is currently playing but no picture displays, there may be a mismatch of the media with the display. Press DEVICE to display the Device Selection menu. Press ENTER for the DVCR device. If digital is selected, try analog, or if analog is selected, try digital.

Sound		
	Symptom	Suggested Solution
1.	There is no sound even when the volume is turned up.	<ul style="list-style-type: none"> • Check audio source in Device Menu. • Check to see if the MUTE button is on. • The TV's "Listen to:" setting may be set to SAP. • Check that the "TV Speakers" setting is On in the Audio/Video menu.
2.	The sound does not match the screen picture.	<ul style="list-style-type: none"> • NetCommand® is set up incorrectly. • The TV's "Listen to:" setting may be set to SAP. • If using stereo or A/V receiver speakers, check their input selection. • If using stereo or A/V receiver, check that AUDIO OUTPUT on TV's back panel is connected to the A/V receiver.
3.	The A/V Receiver is the selected audio source but there is no sound.	<ul style="list-style-type: none"> • Check to see if the A/V Receiver power is turned on. After the power is turned on, redisplay the Device Selection menu and press ENTER to allow NetCommand to correctly select the A/V Receiver input. • Verify the connections and NetCommand setup for the A/V receiver and the desired source device, if any. From the NetCommand menu, select Review. Check the Review screen to see if the A/V Receiver inputs and device listed correspond to the physical connections on the A/V Receiver. If they do not match, either change the physical connections or change the NetCommand setup. To change the NetCommand setup, make the audio source the TV speakers and select a source other than the one you want to change. Next select the Change option on the Edit NetCommand menu to change the A/V receiver input for the device on the Connection screen.

Indicators		
	Symptom	Suggested Solution
1.	Lamp indicator light is a constant red.	Turn the TV off for at least 2 minutes. Turn back on. If light is still red, the lamp has failed. Replace it. See Appendix H for lamp replacement information.
2.	Lamp indicator light is a constant yellow.	Lamp may fail soon. Purchase a new lamp. See Appendix H for lamp replacement information.
3.	Lamp indicator light is a flashing yellow.	Lamp cover door is open or lamp cartridge is not secure. See Appendix H for lamp replacement information.
4.	Status indicator light is a constant yellow.	Room temperature has exceeded proper levels. Cool the room.
5.	Status indicator light is a constant/flashing red.	Service is required. Contact your dealer or a Mitsubishi Authorized Service Center to arrange for a service evaluation. Listings of Mitsubishi Authorized Service locations can be obtained from our web site, www.mitsubishi-tv.com or by calling 1-800-332-2119.

IEEE 1394 Devices		
	Symptom	Suggested Solution
1.	Excessive digital artifacts when viewing an IEEE 1394 device.	<ul style="list-style-type: none"> • The IEEE 1394 cable is too long; 15 feet between devices is the maximum. • There may be a slow device in the middle of the IEEE 1394 network. Move the slow devices to the end so that connections for faster devices do not pass through them.
2.	D-VHS recordings for digital cable have drop-outs (loss of picture or sound), or no playback.	Digital cable signals on IEEE 1394 can exceed the data rate standards supported by DVCR.
3.	There is no audio and video from the IEEE 1394 device.	<ul style="list-style-type: none"> • The device is not turned on. Turn the device power on. • No media (tape or disc) is inserted into the device. • The media is blank (has no recording). • The play command failed - Try pressing play again on the device's remote control or front panel. • The device is already in use (for example, the device is currently recording). • The source is copy-protected or violates copy protection. • The device's digital video signal is not supported by the TV, as may be the case with an IEEE 1394 signal from a computer. Use analog connections instead, if available. • The device is not an audio/video device. • Too many other devices are already communicating over IEEE 1394. Remove or stop some devices and try again.
4.	The IEEE 1394 Device is not listed in the Device Selection menu.	<ul style="list-style-type: none"> • The device is unchecked in the Review screen. Select the NetCommand menu. Through Review, verify the device is checked. • The IEEE 1394 plug is disconnected or loose. • The IEEE 1394 Device has not been powered On. Turn on. • The device has not been discovered. • The device is not an Audio/Video device
5.	The IEEE 1394 device cannot be selected (is grayed out).	The device may be busy, either recording or a peer-to-peer connection has been established. Cancel the recording or peer-to-peer connection.
6.	DEVICE MENU button does not display a menu.	<ul style="list-style-type: none"> • The IEEE 1394 device does not provide a menu. • The TV cannot support IEEE 1394 menus.
7.	All IEEE 1394 devices disappear.	<ul style="list-style-type: none"> • The connected devices must not be in a loop that returns to the TV. Make sure a device is connected at the end. • Disconnect all the cables and devices from the TV. Replace them one by one to locate the problem device or cable • Use System Reset (front control panel).
8.	Cannot rediscover a deleted IEEE 1394 device.	<ul style="list-style-type: none"> • The device has been disconnected. Plug it in. • The device is unchecked in the Review screen. Select NetCommand from the Main menu, then select Review. Check the device. • Remove IEEE 1394 plug. Go to the Edit NetCommand menu. Delete the IEEE 1394 device. Plug the device in again so it can be discovered again.
9.	An IEEE 1394 device has been plugged in but does not appear in the Device Selection menu (not discovered).	<ul style="list-style-type: none"> • The IEEE 1394 connection to the TV or another device is not secure or is loose. • The IEEE 1394 device is not powered on. • A device in the IEEE 1394 chain is not powered on. Turn on all the devices. • The device discovery can take as long as a minute to initiate. • IEEE 1394 cable is too long (maximum of 15 feet between devices). • The IEEE 1394 device uses an incompatible protocol and will not be discovered

IEEE 1394 Devices		
	Symptom	Suggested Solution
10.	Cannot record to or from the IEEE 1394 device, including dubbed recordings.	<ul style="list-style-type: none"> • To initiate a recording to IEEE 1394 device, press the REC key. The Record menu displays allowing setup of the recording. • The source device for the recording is not powered on. • When dubbing, the destination device for the recording is not powered on. • The wrong medium (analog tape for digital recording, or digital tape for the analog recording) is in the device. • The program is copy protected. • The program has already been recorded once and the copy protection only allows one recording. • Unapproved source device for copy protected material. • The recording device can not decode the copyright signal included in the signal source (try another device if available). • The playing device (for dubbing) does not support copyrighted material. • Source for recording is copyrighted • Too many IEEE 1394 devices in network. Insufficient bandwidth available. Disconnect unused devices. • Source Device has higher speed (S 400) than record device. If possible, reverse devices, play in the slower device and record in the faster device.
11.	Cannot control the IEEE 1394 device from the Transport Menu.	<ul style="list-style-type: none"> • Device may not support the command. • Selected function is gray (such as Record for a DVD, which does not support the Record function).

TV Guide On Screen		
<i>(see the separate TV Guide On Screen® Interactive Program Guide User's Manual for detailed information)</i>		
	Symptom	Suggested Solution
1.	TV Guide On Screen® system shows no program listings.	<ul style="list-style-type: none"> • Program listings are downloaded while the TV is off and the cable box is left on. It may take up to 24 hours to begin to receive TV program listings. It may take up to one week to receive all eight days of TV program listings. • Invalid ZIP code was entered at the initial TV Guide On Screen system setup. Select NetCommand from the main TV menu, then Guide and enter the correct ZIP code. • Check the connections between the TV and the TV Guide On Screen input (cable, antenna or cable box and IR cable). At least one antenna connection must be associated with the TV Guide On Screen system to receive program listings.
2.	TV Guide On Screen system program listings don't match actual programs	<ul style="list-style-type: none"> • Incorrect ZIP code was entered at initial TV Guide system setup. Select NetCommand menu, then Guide to enter the correct ZIP code. • For cable programs, there may be more than one cable company in your ZIP code. Refer to the TV Guide On Screen system manual for instructions on the Setup Service.
3.	TV Guide On Screen system does not change channels on the cable box.	<ul style="list-style-type: none"> • Cable box is not set up in NetCommand. The TV Guide On Screen system uses NetCommand to control the cable box and VCR. To correct, select NetCommand from the main TV menu, then select Change or Add on the NetCommand menu and select Cable Box. • NetCommand IR emitter is not in place or properly positioned in front of the cable box remote sensor. See page 32.

Appendices

Appendix A: Specifications	100
Appendix B: On-Screen Information Displays	102
Appendix C: Bypassing the V-Chip Lock.	103
Appendix D: Remote Control Programming Codes	105
Appendix E: Device Control with NetCommand®	108
Appendix F: NetCommand® Specialized Device Keys	110
Appendix G: Cleaning and Service	111
Appendix H: Lamp Cartridge Replacement.	112
Appendix I: Recording and Viewing Combinations	114



Appendix A: Specifications

From time to time, Mitsubishi may offer software updates to expand the features or operation of this TV. When these updates are available they will be announced on our web site, Mitsubishi-tv.com. If you return your owner's registration card, with your model and serial number, you may receive written notification of available software updates.

TV Specifications	
Projection System	DLP, 0.843" chip, 1920 x 1080 pixels with Smooth Picture™
Lamp	WD-52628, WD-62628: 120-watt VIP type
	WD-73727: 150-watt VIP type
Channel Frequency Reception	Over-the-Air: VHF 2–13, UHF 14–69 Analog Cable: 1–125 Digital Cable: 1–135
Channel Type	Over the Air: Analog NTSC, Digital ATSC with sub-channels (all 18 video formats) Cable: Analog NTSC (non-scrambled) Digital QAM 64 and 256 with sub-channels (non-scrambled) CableCARD™: Authorized scrambled and non-scrambled digital channels
Note for Digital Channels: The channel numbers displayed on screen are determined by the broadcaster or cable company and can vary from the standard frequency number. If there is no channel number information included from the broadcaster or cable company, then the TV will create a channel number based on the frequency number as the main channel number and the program number as the sub-channel number. When using an authorized CableCARD, the channel numbers are determined by the cable company.	
Inputs	
Antenna/Cable input Qty. 2	F connector, 75-ohm
HDMI (digital video/audio), Qty. 2 Signal Type	HDMI standard connector HDMI EIA-861B standard for digital audio and video. Video: 480i, 480p, 720p, 1080i Audio: PCM stereo HDMI 1: Not intended for use with personal computers. HDMI 2: Accepts PC input. VGA (640 x 480), 60Hz W-VGA (848 x 480), 60 Hz SVGA (800 x 600), 60Hz W-SVGA (1064 x 600), 60Hz XGA (1024 x 768), 60 Hz 1280 x 720, 60 Hz (EIA standards)
Video/S-Video, Qty. 3 each (1 front, 2 rear)	Video: RCA Pin Plug, 1.0 V p-p, 75 ohm S-Video: Four-Pin DIN Plug Y: 1.0 Vp-p 75-ohm C: 0.286 Vp-p (burst signal), 75-ohm
Signal Type	NTSC 480i only
Component Video (Y/Pr/Pb), Qty. 3 sets	RCA Pin Plug (EIA-770.3 Standard Levels and Timing) Y: 1.0 Vp-p (includes sync), 75-ohm Pr: 700 mV p-p, 75-ohm Pb: 700 mV p-p, 75-ohm
Signal Type	EIA-770.1 & EIA 770.2 480i, 480p, EIA 770.3 720p and 1080i (video standards)

Appendix A: Specifications, continued



Audio Inputs: Qty. 7 pairs	RCA Pin Plug 500 mV (full scale), 43-k ohm	
Outputs		
Video, Qty. 1 Signal Type	Video: RCA Pin Plug 1.0 Vp-p, 75-ohm NTSC 480i only	
Audio:, Qty. 2 pairs	RCA Pin Plug, 500 mV rms \pm 200 mV (full scale) for analog sources, 1.5 Vrms \pm 0.5 Vrms (full scale) for digital sources.	
Digital Interfaces:		
Digital Audio Output, Qty. 1	RCA Pin Plug, Signal Type, Dolby Digital, PCM	
IEEE 1394, Qty. 3 (1 front, 2 rear)	IEEE 1394 Four Pin type Terminal, S400	
Audio/Speakers	Qty. 2 woofers 5.5" x 2.2"; Qty. 2 Tweeters 1.5" round	
Dimensions:	WD-52628	34" H x 49.6" W x 18.6" D, 121 lbs.
	WD-62628	40.5" H x 58.3" W x 19.9" D, 133 lbs.
	WD-73727	44.8" H x 69.9" W x 21.5" D, 188 lbs.
Power Consumption	WD-52628	295 watts
	WD-62628	295 watts
	WD-73727	335 watts

NetCommand® IEEE 1394 System Compatibility:

This television is designed to conform to IEEE 1394 AV/C Software standards in effect at the time of development. This exciting new networking and control technology is designed to provide high-performance digital connections and product control, making the product easier to use.

Mitsubishi D-VHS VCRs are fully compatible with this TV in audio, video, and control.

As other manufacturers distribute products that use the IEEE 1394 AV/C standards, they will be responsible for developing products that meet the standards of the technology, as well as compatibility testing with other products. Mitsubishi cannot be responsible for their efforts, and therefore cannot promise compatibility with these other products. Any compatibility problems with other manufacturers products should be brought to the attention of those manufacturers.

The HDMI input is compliant with EIA-861B standards for standard, extended and high definition video, digital audio and HDCP copy protection. HDMI input 1, however, is not intended for use with personal computers or devices outputting video signals with computer resolutions.

B

Appendix B: On-Screen Information Displays

When you turn on the TV, change devices, change channels, or when you press the INFO button on the remote control, the TV will display the current status. Below are the most common displays. Please note that seldom or never do all of the different status indicators appear at the same time.

Analog Program

1. Antenna or Device being viewed
2. Analog channel being received: If antenna being viewed
3. Channel name (if manually programmed)
4. Signal Type being received
Possible:
Ant-1, Ant-2 or Input 1-3 – 480i
Component 1, 2 – 480i, 480p, 720p or 1080i
5. Screen format being used
Possible:
Analog 480i /480p signals – Standard, Expand, Zoom, Stretch, Stretch Plus, Narrow
720p/1080i signals - Standard, Wide Expand
6. Stereo and/or SAP being broadcast
7. V-Chip Ratings
8. Channel in SuperQuickView bank 2
9. Day and Time
10. Sleep Timer remaining time
11. PIP source and channel
12. Program name (if provided by TV Guide On Screen®)
13. Audio Mute on

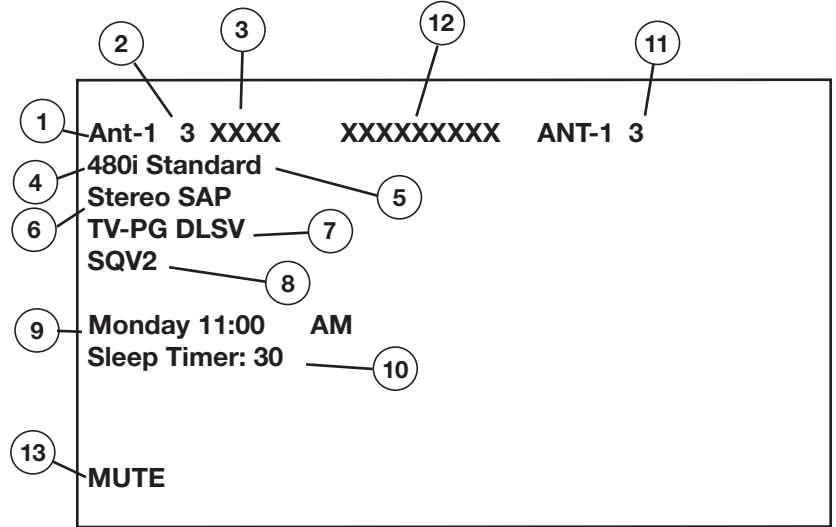

Digital Program

1. Digital Major and Sub channel number
2. Digital Channel Name (only if broadcast)
3. Signal Type being broadcast/received
Possible: SD 4:3, SD 16:9 or HD
4. Screen format being used
Possible:
SD 4:3 - Standard, Expand, Zoom, Stretch, Stretch Plus, Narrow
SD 16:9 or HD - Standard, Wide Expand
5. Language(s) being broadcast
6. Program Name (if broadcast)

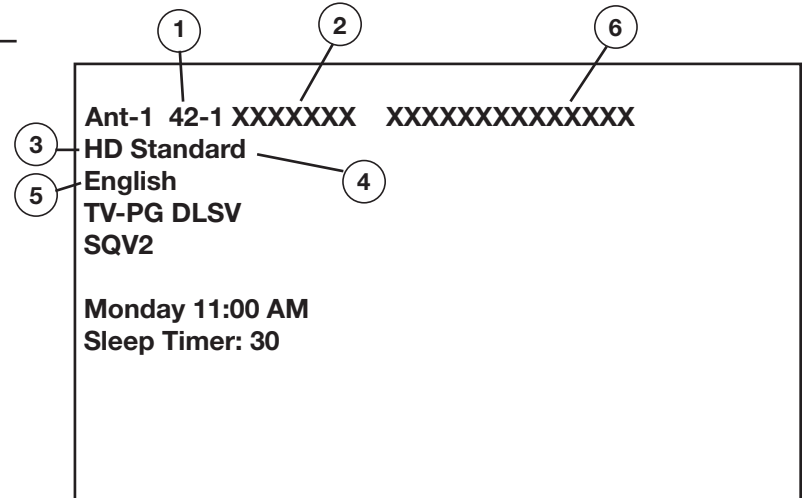

Digital IEEE 1394 Device

1. Status of D-VHS VCR or IEEE 1394 device
2. Counter of D-VHS VCR
3. Media type in D-VHS VCR
4. Special message line
(shows only when a special message is needed; may be seen with Analog signals)

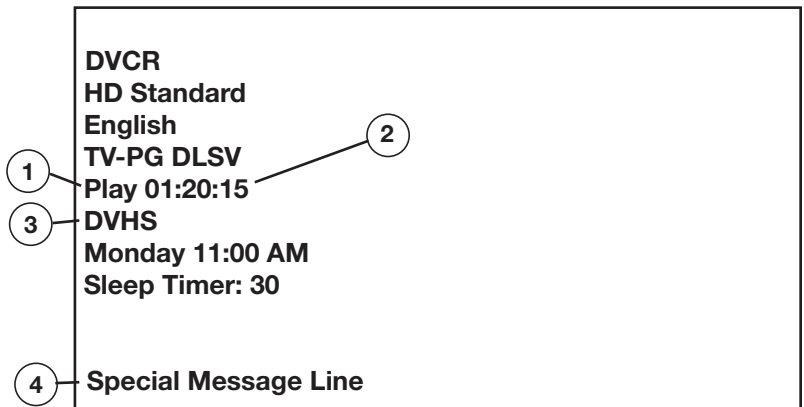



Lock Bypass Instructions Have Been Filed for Future Reference

Bypassing the V-Chip Lock

After you set the lock, you need your pass code to view a V-Chip locked program, view the locked TV, cancel the lock, or enter the V-Chip Lock menus.

If you forget your pass code, you can view the locked TV without entering your pass code. When you are prompted for your pass code, press the number 9 and QV buttons on the TV remote control at the same time. This process temporarily unlocks the TV

When entering the V-Chip Lock menu, this process deletes your old pass code and prompts you to enter a new pass code. Press HOME to exit the menu.

Deactivating the Front Button Lock

Press and hold the MENU button on the TV front panel for over eight seconds.

IMPORTANT

Cut along the dotted line and file bypass instructions in a safe place for future reference.

IMPORTANT

When changing or deleting your pass code, you must use the remote control included with this TV. You cannot use a Mitsubishi remote control from another component or a “universal” remote.

This page intentionally blank

Appendix D: Remote Control Programming Codes



IMPORTANT

The remote control may return to its initial setting when the batteries are changed. You may need to reprogram.

Programming the Remote to Control NetCommand A/V Products

1. Move the slide switch at the top of the remote to the TV position.
2. Press and hold POWER on the remote control.
3. Enter the three digit code of 935, and then release POWER.
4. When the remote control is in the TV position, it is now programmed to send NetCommand signals to the TV so the TV can control the IEEE 1394 devices and NetCommand-supported or learned IR devices. This is the default setting for the remote control.

Programming the Remote to Control Other Brands of Audio and Video Products

1. Move the slide switch at the top of the remote to the product you want to control.
2. Press and hold POWER on the remote control.
3. Enter the first three digit code listed for your equipment, and then release the POWER button on the remote control.
4. Point the remote control at the equipment and press the POWER button. If the equipment responds, the remote control is properly programmed to operate the equipment. If the equipment does not respond, repeat steps 2–4 with the next three-digit code listed in step 3 for your equipment.

A/V Receivers

A/V Receiver Brand	Code
MITSUBISHI	010, 011, 012, 013, 014
AIWA	225, 226, 241
BOSE	351
B & K	352
DENON	234, 235, 236, 245, 246, 359, 361
FISHER	204
GARRARD	213
HARMAN KARDON	215, 223, 242, 362
JENSEN	223, 229
JVC	232, 233
KENWOOD	200, 208
KLH	363
KOSS	357
MAGNAVOX	227, 228
MARANTZ	224, 350, 360
MCINTOSH	216
NAKAMICHI	206, 217
ONKYO	209, 214, 240, 247
OPTIMUS	203, 227, 231, 230
PANASONIC	219, 218, 221
PARASOUND	356
PHILIPS	223, 248
PIONEER	205, 207
POLK AUDIO	353
QUASAR	219, 218, 221
RCA	203, 205, 227, 231, 230
ROTEL	366
SANSUI	203, 211, 239
SHARP	234, 237
SHERWOOD	354, 355
SONY	222, 249, 364, 365
TEAC	212, 213, 211, 210
TECHNICS	221, 218, 219
VICTOR	232, 233
YAMAHA	201, 202, 243, 244

Cable Boxes

Cable Brand	Code
ABC	124
ARCHER	125
CABLEVIEW	105,
CITIZEN	122, 105
COLOR VOICE	128, 129, 130, 106, 107
COMTRONICS	128, 129, 130, 106, 107
CURTIS	112, 113
DIAMOND	124, 125
EAGLE	129
GCBRAND	105
GE	112, 113
GEMINI	122
GENERAL INSTRUMENT/ JERROLD/MOTOROLA	119, 123, 124, 125, 126, 127, 120, 121, 122
HAMLIN	112
HITACHI	103, 124
MACOM	103, 104, 105, 108
MAGNAVOX	128, 129, 130, 106, 107, 133, 138
MOTOROLA	123, 146
MEMOREX	130
MOVIE TIME	105,
PANASONIC	114
PARAGON	117
PHILIPS	128, 129, 130, 106, 107, 131, 133, 138
PIONEER	101, 106, 116
PULSAR	105
RCA	115
REGAL	112
REMBRANDT	105, 138
SAMSUNG	105
SONY	147, 177
ZENITH/DRAKE SATELLITE	100



Appendix D: Remote Control Programming Codes, continued

Cable Boxes, continued

SCIENTIFIC ATLANTA	112, 113, 194
SIGNATURE	119,124,125,126,127,120,121,122
SLMARK	105,101
SPRUCER	105
STARCOM	119,124,125,126,127,120,121,122
STARGATE	105
TELEVIEW	101,105
TOCOM	135,136
TOSHIBA	104
UNIKA	125
UNITED CABLE	119,124,125,126,127,120,121,122
UNIVERSAL	122
VIDEOWAY	106
VIEWSTAR	129,130
ZENITH	117,100

DVD Players

DVD Brand	Code
DAEWOO	030, 031
DIMENSIA	065
EMERSON	063, 046, 038, 039, 023, 045, 062, 040
FISHER	025, 028, 029, 027
FUNAI	047, 046, 040
GE	053, 065, 044, 079
GO VIDEO	057, 069, 070, 071
GOLDSTAR	026
HITACHI	043, 065, 020, 047
INSTANT REPLAY	044, 043
JVC	030, 031, 076, 077
KENWOOD	030, 026, 031
LXI	047, 026, 020, 027, 028, 025, 029
MAGNAVOX	051, 043, 044
MARANTZ	030, 031
MARTA	026
MEMOREX	044, 029
MGA	060, 067, 068, 061, 062
MINOLTA	020, 065
MULTITECH	067, 047
NEC	030, 031
OLYMPIC	044, 043
OPTIMUS	048, 041, 055, 026
ORION	046, 040
PANASONIC	043, 044, 041, 042
PENNEY	044, 020, 065, 025, 030, 031
PENTAX	020, 031, 065
PHILCO	051, 044, 047, 043, 046, 040, 063
PHILIPS	051, 043, 044
PIONEER	043
PROSCAN	065, 020, 043, 044, 051, 066, 021, 022, 053
QUASAR	041, 042, 043, 044
RADIO SHACK	053, 044, 025, 056, 029, 060, 047
RCA	020, 021, 022, 043, 044, 049, 051, 053, 065, 066
REALISTIC	044, 025, 056, 029, 060, 047
SAMSUNG	057, 022, 053
SANSUI	046, 040
SANYO	025, 029
SCOTT	021, 022, 029, 060, 067, 068, 046, 040
SEARS	025, 026, 027, 028, 020
SHARP	055, 056
SIGNATURE 2000	047, 055
SONY	048, 049, 050, 073, 074, 075
SV2000	047
SYLVANIA	051, 043, 044, 047
SYMPHONIC	047
TASHIRO	026
TATUNG	030, 031
TEAC	030, 047, 031
TECHNICS	041, 042, 043, 044
TEKNIKA	044, 047
TOSHIBA	021, 066
TOTEVISION	026
VECTOR RESEARCH	031
WARDS	055, 056, 029, 064, 026
YAMAHA	025, 030, 031
ZENITH	064, 026

Satellite Receivers/SAT/DTV

Brand	Code
MITSUBISHI	006 (same as 173)
ECHOSTAR/DISH NETWORK	175, 182, 183, 188
EXPRESS VU	175
G.E.	176
HITACHI	173, 181, 184
HNS (Hughes)	173
JVC (ECHOSTAR)	175
MAGNAVOX	171, 172
PANASONIC	174
PHILIPS	171, 172
PROSCAN	176, 179, 180, 185
RCA	176, 179, 180, 185
SAMSUNG - TERRESTRIAL	192
SONY	177
STAR CHOICE	173
TOSHIBA	170, 189, 190, 191
UNIDEN	171, 172
WEBTV	187
ZENITH/LG	193

VCRs

VCR Brand	Code
MITSUBISHI	001, 060, 067, 068, 061, 062, 002
AKAI	049, 034, 035, 036
AUDIO DYNAMIC	031
BELL & HOWELL	025,
BROKSONIC	040, 046
CANON	043, 045
CITIZEN	026
CRAIG	025, 049, 026
CURTIS MATHES	065, 044, 047
DAEWOO	063, 021, 044, 078
DBX	030, 031
DIMENSIA	065
EMERSON	063, 046, 038, 039, 023, 045, 062, 040
FISHER	025, 028, 029, 027
FUNAI	047, 046, 040
GE	053, 065, 044, 079
GO VIDEO	057, 069, 070, 071
GOLDSTAR	026
HITACHI	043, 065, 020, 047
INSTANT REPLAY	044, 043
JVC	030, 031, 076, 077
KENWOOD	030, 026, 031
LXI	047, 026, 020, 027, 028, 025, 029
MAGNAVOX	051, 043, 044
MARANTZ	030, 031
MARTA	026
MEMOREX	044, 029
MGA	060, 067, 068, 061, 062
MINOLTA	020, 065
MULTITECH	067, 047
NEC	030, 031
OLYMPIC	044, 043
OPTIMUS	048, 041, 055, 026
ORION	046, 040
PANASONIC	043, 044, 041, 042
PENNEY	044, 020, 065, 025, 030, 031
PENTAX	020, 031, 065
PHILCO	051, 044, 047, 043, 046, 040, 063
PHILIPS	051, 043, 044
PIONEER	043
PROSCAN	065, 020, 043, 044, 051, 066, 021, 022, 053
QUASAR	041, 042, 043, 044
RADIO SHACK	053, 044, 025, 056, 029, 060, 047
RCA	020, 021, 022, 043, 044, 049, 051, 053, 065, 066
REALISTIC	044, 025, 056, 029, 060, 047
SAMSUNG	057, 022, 053
SANSUI	046, 040
SANYO	025, 029
SCOTT	021, 022, 029, 060, 067, 068, 046, 040
SEARS	025, 026, 027, 028, 020
SHARP	055, 056
SIGNATURE 2000	047, 055
SONY	048, 049, 050, 073, 074, 075
SV2000	047
SYLVANIA	051, 043, 044, 047
SYMPHONIC	047
TASHIRO	026
TATUNG	030, 031
TEAC	030, 047, 031
TECHNICS	041, 042, 043, 044
TEKNIKA	044, 047
TOSHIBA	021, 066
TOTEVISION	026
VECTOR RESEARCH	031
WARDS	055, 056, 029, 064, 026
YAMAHA	025, 030, 031
ZENITH	064, 026

Appendix D: Remote Control Programming Codes, continued



IMPORTANT

Some manufacturers may change their products, or they may use more than one remote control system. If this is the case, the TV remote control may not be able to operate your VCR, DVD, cable box, satellite receiver, or A/V receiver.

After entering the correct codes in each position of the remote control, use the slide switch to select which product will respond when an operational button is pressed. Only one of the below devices is allowed for each slide switch position.

TV position:

- TV, NetCommand® Controlled Devices

Cable/SAT/DTV position:

- Cable box
- Satellite receiver
- DTV receiver

VCR position:

- VCR

DVD position:

- DVD
- LD Player

Audio position:

- A/V receiver
- Mitsubishi CD player

If you have a Mitsubishi A/V receiver, the audio position may be used in conjunction with select Mitsubishi CD players. Your audio position must be programmed to 010.

When your remote control has been programmed to operate another manufacturer's product, the function performed on each layer can vary. The most common functions are:

VCR

- POWER
- CHANNEL up/down
- PLAY
- REC
- PAUSE
- STOP
- FF/FWD
- REW/REV

Mitsubishi VCRs will be compatible with some additional buttons

Cable Boxes and Satellite Receivers

- POWER
- CHANNEL up/down
- 0-9 number buttons (on some models)
- ENTER (on some models)
- CANCEL (on some models)
- ADJUST up/down/ left/right (on some models)
- GUIDE (on some models)

A/V Receivers

- POWER
- VOLUME
- MUTE

Mitsubishi A/V Receivers

- Direct Input Selection buttons: numbers, SQV and QV (on some models)

Mitsubishi CD Players

(not all functions for all models)

- PLAY
- FF/FWD
- REW/REV
- PAUSE
- STOP

DVD and Laser Disc Players

(not all functions for all models)

- POWER
- MENU
- 0-9 number buttons (on some models)
- PLAY
- STOP
- ARROW up/down/left/right (on some models)
- FF/FWD
- REW/REV
- PAUSE
- CANCEL (on some models)
- ENTER
- CHANNEL (on some models)



Appendix E: Device Control with NetCommand®

NetCommand Compatible Traditional Devices (Analog)				
When Device Selection Menu is Displayed and the Device is Highlighted (Yellow Outline)				
Device Remote Control Button	A/V RECEIVER	VCR	DVD	CABLE BOX/SAT
POWER	Power On/Off (toggle)	Power On/Off (toggle)	Power On/Off (toggle)	Power On/Off (toggle)
GUIDE	Changes between digital and analog audio	Changes VCR inputs	n/a	Changes antenna inputs (RCA model DTC-100 only)
FORMAT	n/a	n/a	Changes output between interlaced and progressive	Changes output between HD and SD select models

When NetCommand® Compatible Traditional Device is Viewed or Played				
Device Remote Control Button	A/V RECEIVER	VCR	DVD	CABLE/SAT
CH up/down		Channel up/down	Skip Forward/Backwards Chapter or Track	Channel up/down Page up/down when guide showing
VOL up/down	Volume Up/Down			
MUTE	Mute On/Off			
0-9 (digits)		number functions	number functions	number functions
QV				Last Channel Recall
DEVICE Menu		1st press Transport Menu, 2nd press Setup Menu display	1st press Transport Menu, 2nd press Setup Menu display	Setup menu display or Action function
HOME				
ENTER			Enter or select	Enter or select
CANCEL		Counter Reset	Exit or return	Exit or return
GUIDE			Disc menu display	Channel Guide
ADJUST			up/down left/right	up/down left/right
PLAY		Play	Play	
STOP		Stop	Stop	
RECORD		Record		
REW/REV		Rewind/Reverse	Reverse	
FF/FWD		Fast Forward or Fast Play	Fast Play	

Appendix E: Device Control with NetCommand®, continued



IEEE 1394 Devices				
When Device Selection Menu is Displayed and the Device is Highlighted (Yellow Outline)				
Device Remote Control Button	TUNER/ CABLE BOX/ SAT	A/V DISC	DVCR	AMPLIFIER
POWER	Power On/Off (toggle)	Power On/Off (toggle)	Power On/Off (toggle)	Power On/Off (toggle)
GUIDE	n/a	n/a	n/a	n/a
FORMAT	n/a	n/a	n/a	n/a

When an IEEE 1394 Device is Viewed or Played				
Device Remote Control Button	CABLE/SAT	TV Disc or A/V DISC	DVCR	AMPLIFIER
CH up/down	Channel up/down	Page up/down (when track list is displayed)	Index search forward/reverse (if supported by DVCR)	
VOL up/down				Volume Up/Down
MUTE				Mute On/Off
0-9 (digits)	number functions	Search by time (when followed by ENTER)		
QV	Last Channel Recall			
DEVICE Menu	n/a	Transport Menu redisplay	Transport Menu redisplay	Device Menu
HOME	Exit menus/displays	Exit menus/displays	Exit menus/displays	Exit menus/displays
ENTER	Enter or select	Enter or select	Enter or select	Enter or select
CANCEL	Cancel function	Cancel function	Cancel function or Counter Reset	Cancel function
GUIDE	Digital Channel Guide	Track or program list display	Program Guide	
ADJUST	up/down left/right	Skip Forward 30 seconds (during playback) Skip Backwards 12 seconds (during playback) Skip to end or beginning of program Page up/down in track list	up/down left/right	up/down left/right
PLAY		Play	Play	
STOP		Stop	Stop	
RECORD		Record	Record	
REW/REV		Reverse picture scan or Slow Play	Reverse or Slow Play	
FF/FWD		Fast picture scan or Fast Play	Fast Play	

F

Appendix F: NetCommand® Specialized Device Keys

A/V RECEIVER	CABLE or SAT	VCR	DVD	LEARNING SCREEN CHECK BOX NAME	FUNCTION	NAME ON TV REMOTE
X	X	X	X	Power*	Power On or Power On/Off	POWER**
X	X	X	X	Power (Off)*	Power Off	POWER**
X				Volume Up	Volume Up	VOL ▲
X				Volume Down	Volume Down	VOL ▼
X				Mute	Mute	MUTE
X				Analog to Digital*	Analog/Digital Switch	GUIDE**
X				Digital to Analog*	Digital/Analog Switch	GUIDE**
X				Input (1-7)	AVR Input Select	Automatic (when device is selected)
	X	X		Channel Up	Channel Scan Up	CHAN ▲
	X	X		Channel Down	Channel Scan Down	CHAN ▼
	X			Recall	Last Channel Recall	QV
	X		X	Guide	Guide	GUIDE
	X	X	X	Adjust Up	Arrow/move Up	ADJUST ▲
	X	X	X	Adjust Down	Arrow/move Down	ADJUST ▼
	X	X	X	Adjust Left	Arrow/move Left	ADJUST ◀
	X	X	X	Adjust Right	Arrow/move Right	ADJUST ▶
	X	X	X	Enter	Enter/Select	ENT
	X	X	X	Menu	Device Menu or Setup Menu	DEVICE MENU
	X	X	X	Cancel	Cancel or Exit	CANCEL
	X	X	X	Info	Status Information Display	INFO
	X			Page Up	Guide Page Up	CHAN ▲ ***
	X			Page Down	Guide Page Down	CHAN ▼ ***
	X	X	X	Play	Play	PLAY
	X	X	X	Stop	Stop	STOP
	X	X	X	Forward	Fast Forward/Fwd Search	FF
	X	X	X	Rewind	Rewind/Reverse Search	REW
	X	X	X	Pause	Pause	PAUSE
	X	X	X	Record	Record	REC
	X	X	X	Enter (digits)†	Enter for channel numbers	ENT
	X	X	X	Low Speed Out*	Low Speed 480i out	FORMAT**
	X	X	X	High Speed Out*	Hi Speed 480p/1080i out	FORMAT**
	X	X	X	1,2,3,4,5,6,7,8,9,0	1,2,3,4,5,6,7,8,9,0	1,2,3,4,5,6,7,8,9,0
	X	X		Input	Input Change	GUIDE**
		X		Sub channel separator‡	Digital Sub channel	CANCEL
			X	Chapter +	Chapter Skip Forward	CHAN ▲
			X	Chapter -	Chapter Skip Reverse	CHAN ▼

* These are paired functions (e.g. Power and Power Off). When the original remote control uses a single button for both functions, learn only the first of the paired functions.

† If there are two Enter keys, learn the Enter key used for channel selection here. The ENT button on the remote sends the correct IR code when digits are entered.

‡ Learn the subchannel separator if a special key is used to add a separator (dash or dot) in a digital channel. Press the CANCEL button on the remote to add the separator

** This function is performed only when the Device Selection Menu is displayed and the device icon is highlighted.

*** Channel Up/Down as Guide Page Up/Down happens only after pressing GUIDE and returns to channel functions after pressing ENTER or CANCEL.

Appendix G: Cleaning and Service



IMPORTANT

DO NOT use any kind of abrasive cleaner on the surface of the TV screen.

Cleaning

Normally, light dusting with a dry, non-scratching duster will keep your TV clean. If cleaning beyond this is needed, please use the following guidelines:

First, turn off the TV and unplug the power cord from the power outlet.

Top and Sides of the TV:

- Gently wipe down your TV with a soft, non-abrasive cloth such as cotton flannel or a clean cloth diaper, lightly moistened with water. Dry with a second dry, soft, non-abrasive cloth.
- For oily dirt, add a few drops of mild liquid detergent, such as dishwashing detergent, to the water used to moisten the cloth. Rinse with a second cloth moistened only with water. Dry with a third dry, soft, non-abrasive cloth.

Screen:

- Follow the instructions for the top and sides, however, wipe gently in an up and down motion, following the grooves in the screen.
- Clean the entire screen evenly, not just sections of the screen.
- Do not allow liquid to drip down the grooves of the screen, as some liquid may enter the TV between the screen and the screen frame.
- You may purchase Mitsubishi Screen Cleaner, part number CLEANER-VSS, by calling (800) 553-7278.

General Cleaning Warnings:

- DO NOT allow liquid to enter the TV through the ventilation slots or any crevice.
- DO NOT use any strong or abrasive cleaners as these can scratch the surfaces.
- DO NOT use any cleaners with ammonia, bleach, alcohol, benzine, or thinners as these can dull the surfaces.
- DO NOT spray liquids or cleaners directly on the TV's surfaces.
- DO NOT scrub or rub the TV harshly. Wipe it gently.

Service



If you are unable to correct a problem with your TV, consult your Mitsubishi dealer or a Mitsubishi Authorized Warranty Service Center.

- DO NOT adjust any controls other than those described in this Owner's Guide.
- DO NOT remove the protective back cover of your TV.

Menus not described and shown in this owner's guide are designed for factory use and for authorized service personnel. Damage caused to the TV by non-authorized changes or changes to these menus made by non-authorized persons are not covered under warranty.



Appendix H: Lamp Cartridge Replacement

	CAUTION	
BURN DANGER!		
During normal operation, the surfaces inside the TV near the lamp are extremely hot.		
TOUCH THE LAMP CARTRIDGE BY THE HANDLE ONLY Do not touch the glass parts of the lamp cartridge.		

CAUTION: If the television is on, press **POWER** to turn it off. Allow the television to cool for one hour before attempting to replace the lamp cartridge.

LAMP LIFE

The light source for this television is a lamp, which is part of a lamp cartridge assembly. The actual life of the lamp in this television can vary, based on the lamp itself, the air temperature around the TV while it is operating, and your viewing patterns. Warmer air or poor ventilation shortens the lamp life, as does turning the television on and off frequently.

When the end of the lamp's life is approaching, the TV displays a warning message for one minute when you power on the TV. The message will reappear the next five times you turn on the TV. After you change the lamp cartridge, you must reset the lamp reminder through the TV Setup menu. Otherwise, the warning message will appear again before necessary. Mitsubishi warrants the lamp for one (1) year from date of the original purchase at retail. It is likely, however, that the lamp will last significantly longer than this.

TO ORDER A NEW LAMP:

While Under Warranty	After Warranty	
Call (800) 332-2119. Please have model number, serial number, and TV purchase date available.	Call (800) 553-7278. Order a new lamp for your TV model as shown below.	
	<i>TV Model Number</i>	<i>Lamp Part Number</i>
	WD-52628	915P026010
	WD-62628	915P027010
	WD-73727	915P027010

WARNING:

Do not remove the lamp cartridge immediately after turning off the television. You may get burned because of the lamp's high temperature. Allow the television to cool for one hour before attempting to replace the lamp cartridge.

Do not remove the lamp cartridge except when replacing it. Careless treatment can result in injury or fire.

Do not touch the lamp glass element. It may be very hot and break, causing injuries or burns.

Be sure not to insert any metal or flammable object into the lamp cartridge opening, as it may cause fire or electrical shock. If any object is inserted into the opening, unplug the AC cord of the TV and contact your dealer for service.

Install the lamp cartridge securely. Failure to do so may cause a fire.

Do not touch the lamp glass elements. Oils from your fingers may cause premature lamp failure.

The lamp in this product contains mercury. Disposal of mercury may be regulated due to environmental considerations. For disposal or recycling information, please contact your local authorities or the Electronic Industries Alliance at: www.eiae.org.

IMPORTANT

Reset the lamp hours through the TV setup menu each time you replace the lamp cartridge. Otherwise, the lamp warning message will reappear sooner than necessary.

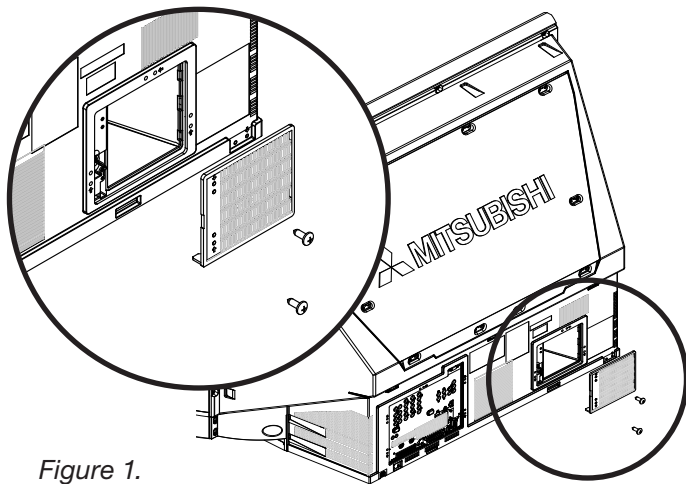

Figure 1.

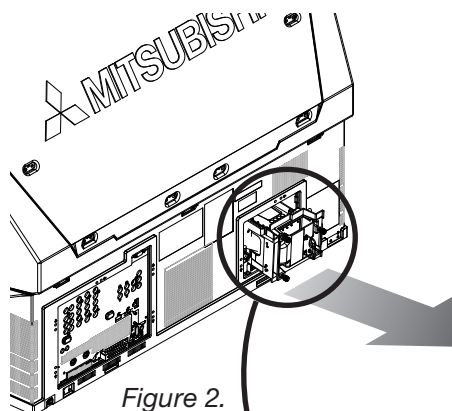

Figure 2.

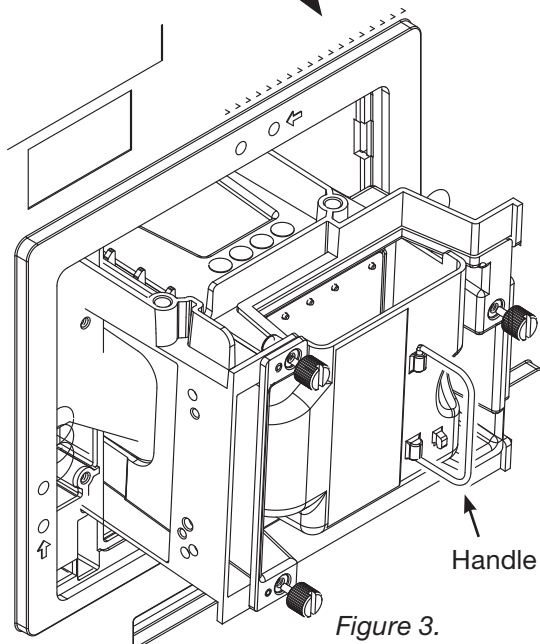

Figure 3.

WARNING

THE GRILLE/COVER IS PROVIDED WITH AN INTERLOCK TO REDUCE THE RISK OF EXCESSIVE ULTRAVIOLET RADIATION. DO NOT DEFEAT ITS PURPOSE OR ATTEMPT TO SERVICE THE TV WITHOUT REMOVING THE GRILLE/COVER COMPLETELY.

1. Turn TV power off and allow the lamp to cool at least one hour before proceeding.
2. After the lamp has cooled, remove the plastic air exhaust grille/cover by removing two screws with a #2 (large) Phillips screwdriver. See figure 1.
3. With a large flat-blade screwdriver, loosen the three shiny screws securing the lamp cartridge until they disengage from the mating threads. These are captive screws and cannot be separated from the lamp cartridge.
4. Fully open up the bag supplied with the replacement lamp and set the opened bag aside. If no bag was supplied, use any available small paper bag.
5. Grasp the wire handle of the lamp cartridge and pull the old cartridge straight out towards you. See figures 2 and 3. Note the orientation of the cartridge.

CAUTION: Do not tilt or rotate the cartridge, as small glass fragments may fall out.
6. Without tilting or putting down the lamp cartridge, insert it into the opened bag. Close the bag while being careful that no glass particles fall out.
7. Do not touch the glass parts of the new lamp cartridge. Insert the new cartridge into the TV in the same orientation as the old cartridge. Push on the cartridge housing until it is fully seated.
8. With either your fingers or the screwdriver, gently tighten the three screws. If using a screwdriver, use only two fingers for final tightening. **AVOID OVERTIGHTENING!**
9. Replace the plastic grille/cover and retaining screws.
10. **WASH YOUR HANDS THOROUGHLY, AS THIS LAMP CONTAINS MERCURY.**
11. Contact your local authorities or the Electronic Industries Alliance at www.eiae.com for lamp-disposal or recycling instructions. Do not dispose of the old lamp with common trash.
12. Reset the Lamp Reminder from the TV Setup menu as follows:
 - a. Press TV MENU to open the Setup menu.
 - b. Move the highlight to Lamp Reminder.
 - c. Press ENTER twice.



Appendix I: Recording and Viewing Combinations

The tables in this appendix show which program sources you can watch while a recording is in progress.

Analog VCR Connected to Audio and Video Record Outputs

When recording this (source device)	You can watch any one of these (viewing device)					
	<i>Same as Recording</i>	<i>Different Antenna or Channel</i>	<i>Input 1-3 Devices</i>	<i>Component 1-3 Devices</i>	<i>IEEE-1394 Device</i>	<i>HDMI Device</i>
Ant-1 Air/Cable Analog Channel	Yes	No	Yes	Yes	Yes	Yes
Ant-1 Air/Cable Digital Channel	Yes	No	Yes	Yes	No	Yes
Ant-1 CableCARD Analog Channel	Yes	No	Yes	Yes	Yes	Yes
Ant-1 CableCARD Digital Channel	Yes	No	Yes	Yes	No	Yes
Ant-2 Air/Cable Analog Channel	Yes	No	Yes	Yes	Yes	Yes
Ant-2 Air/Cable Digital Channel	Yes	No	Yes	Yes	No	Yes
Input 1-3 Video or S-Video Devices	Yes	Yes	Yes	Yes	Yes	Yes
IEEE-1394 Device	Yes	No	Yes	Yes	Yes, same as recording	Yes
Component 1-3	Cannot record from this source					
HDMI Device	Cannot record from this source					



Digital VCR or A/V Disc Connected to IEEE-1394 Port

When recording this (source device)	You can watch any one of these (viewing device)					
	<i>Same as Recording</i>	<i>Ant-1/Ant-2 Channels</i>	<i>Input 1-3 Devices</i>	<i>Component 1-3 Devices</i>	<i>IEEE-1394 Device</i>	<i>HDMI Device</i>
Ant-1 Air/Cable Analog Channel	Cannot make digital recordings from this source					
Ant-1 Air/Cable Digital Channel	Yes	No	Yes	Yes	Yes	Yes
Ant-1 CableCARD Analog Channel	Cannot make digital recordings from this source					
Ant-1 CableCARD Digital Channel	Yes	No	Yes	Yes	Yes	Yes
Ant-2 Air/Cable Analog Channel	Cannot make digital recordings from this source					
Ant-2 Air/Cable Digital Channel	Yes	No	Yes	Yes	Yes	Yes
Input 1-3 Video or S-Video Devices	Cannot make digital recordings from this source					
IEEE-1394 Device	Yes	Yes	Yes	Yes	Yes	Yes
Component 1-3	Cannot record from this source					
HDMI Device	Cannot record from this source					

Trademark and License Information

LICENSOR'S SUPPLIERS DO NOT MAKE OR PASS ON TO END USER OR ANY OTHER THIRD PARTY, ANY EXPRESS, IMPLIED OR STATUTORY WARRANTY OR REPRESENTATION ON BEHALF OF SUCH SUPPLIERS, INCLUDING, BUT NOT LIMITED TO THE IMPLIED WARRANTIES OF NON-INFRINGEMENT, TITLE, MERCHANTABILITY OR FITNESS FOR A PARTICULAR PURPOSE.

CableCARD™ is a trademark of Cable Television Laboratories, Inc.

CompactFlash® and CF are trademarks of the CompactFlash Association.

DCR™ Certification Logo is a trademark of the Consumer Electronics Association.

Digital Light Processing™ and DLP™ are trademarks of Texas Instruments.

Manufactured under license from Dolby Laboratories. Dolby® and the double-D symbol are registered trademarks of Dolby Laboratories.

DTVLINK™ Certification Logo is a trademark of the Consumer Electronics Association.

Firewire® is a trademark of Apple Computer, Inc. registered in the U.S. and other countries.

HDMI™ the HDMI logo and High-Definition Multimedia Interface are trademarks or registered trademarks of HDMI Licensing LLC.

Lifestyle® 28 is a trademark of the Bose Corporation.

This product incorporates copyright protection technology that is protected by U.S. patents and other intellectual property rights. Use of this copyright protection technology must be authorized by Macrovision, and is intended for home and other limited pay-per-view uses only unless otherwise authorized by Macrovision. Reverse engineering or disassembly prohibited.



Memory Stick™ and Memory Stick PRO™ are trademarks of Sony Corp.

Microdrive® is a registered trademark of Hitachi Global Storage Technology, Inc. in the United States and/or other countries.

This product includes technology owned by Microsoft Corporation and cannot be used or distributed without a license from Microsoft Licensing, Inc.

MultiMediaCard™ is trademark of Infineon Technologies and licensed to the MultiMediaCard Association.



The PanelLink Cinema Partners logo and the "PanelLink Cinema," "PLC" and "PLC Content Ready" word marks are trademarks of Silicon Image, Inc. and are used under a license from Silicon Image, Inc or PanelLink Cinema, LLC.

Playstation® 2 is a trademark of the Sony Corporation.



SD logo is a trademark.

SmartMedia™ is a trademark of Toshiba Corp.

In the United States, TV GUIDE and other related marks are registered marks of Gemstar-TV Guide International, Inc. and/or one of its affiliates.

The TV Guide On Screen® system is manufactured under license from Gemstar-TV Guide International, Inc. and/or one of its affiliates.

The TV Guide On Screen® system is protected by one or more of the following issued United States patents: 6,498,895; 6,418,556; 6,331,877; 6,239,794; 6,154,203; 5,940,073; 4,908,713; 4,751,578; 4,706,121.

XBox™ is a trademark of the Microsoft Corporation.

MonitorLink™, NetCommand®, ViewPoint®, QuickView™, SuperQuickView™, PerfectColor™, MediaCommand™, ChannelView™ are trademarks of Mitsubishi Digital Electronics America, Inc.

MITSUBISHI TV SOFTWARE

END-USER LICENSE AGREEMENT FOR EMBEDDED SOFTWARE

IMPORTANT – READ CAREFULLY: This License Agreement is a legal agreement between you (either an individual or an entity) and Mitsubishi Digital Electronics America, Inc. (MDEA) for all software pre installed and/or provided along with this television (“Software”). By utilizing this television and Software, you agree to be bound by the terms of this License Agreement.

The Software is protected by United States copyright laws and international treaty provisions, as well as other intellectual property laws and treaties. The Software is licensed, not sold.

1. **LICENSE GRANT.** MDEA grants you a non-exclusive, non-transferable, limited right and license to use one copy of the Software only with the Mitsubishi television model that included this owner’s guide and owned by you.

2. **RIGHTS AND LIMITATIONS.**

Software Not for Resale. You may not resell or otherwise transfer for value the Software, except in conjunction with a sale of the TV that Software has been pre installed.

Prohibition on Reverse Engineering, Decompilation and Disassembly. The Software contains trade secrets or other proprietary material in its human perceivable form and to protect them, you may not reverse engineer, decompile, or disassemble, or otherwise reduce the Software to any human perceivable form, except to the extent that the foregoing restriction is expressly prohibited by applicable law.

Separation of Components. The Software is licensed as a single product. Its component parts may not be separated for use on more than one TV.

No Rental. You may not rent, lease, lend, or sublicense the Software.

Trademarks. This License Agreement does not grant you any rights to any trademarks of MDEA.

3. **VIOLATIONS.** You understand that any use, copying or transfer of the Software, except as permitted pursuant to this License, may subject you to serious criminal and civil penalties including damages and an award to MDEA of attorneys’ fees in connection with any violation of this License. You further understand that you may be held legally responsible for any copyright infringement or other violation of intellectual property rights that is caused, encouraged, or induced by your failure to abide by the terms of the License. This license is effective until terminated, and will terminate immediately without notice from MDEA or judicial resolution if you fail to comply with any provision of this License.

4. **COPYRIGHT.** All title and intellectual property rights in and to the Software (including but not limited to any images, photographs, animations, video, audio, music, text, and “applets” incorporated into the Software), and any accompanying printed materials are owned by or licensed to MDEA. All title and intellectual property rights in and to the content which may be accessed through use of the Software is the property of the respective content owner and may be protected by applicable copyright or other intellectual property laws and treaties. This License Agreement grants you no rights to use such content, except that you own the media on which the Software is recorded, but MDEA and its licensors retain ownership of the Software itself. All rights not expressly granted are reserved by MDEA.

5. **EXPORT RESTRICTIONS.** MDEA is licensing the Software for use within the United States. You agree that you will not export or re-export the Software. You specifically agree not to export or re-export the Software: (i) to any country to which the U.S. has embargoed or restricted the export of goods or services, which currently include, but are not necessarily limited to Cuba, Iran, Iraq, Libya, North Korea, Sudan, and Syria, or to any national of any such country, wherever located, who intends to transmit or transport the Software back to such country; (ii) to any person or entity who you know or have reason to know will utilize the Software in the design, development, or production of nuclear, chemical, or biological weapons; or (iii) to any person or entity who has been prohibited from participating in U.S. export transactions by any federal agency of the U.S. government. You warrant and represent that neither the BXA nor any other U.S. federal agency has suspended, revoked, or denied your export privileges.

6. **DISCLAIMER OF WARRANTY. EXCEPT AS OTHERWISE PROVIDED IN THIS LICENSE OR IN THE LIMITED WARRANTY APPLICABLE TO THE TV, MDEA MAKES NO OTHER WARRANTIES OF ANY KIND WHATSOEVER REGARDING THE SOFTWARE AND HEREBY EXPRESSLY DISCLAIMS ALL WARRANTIES OF ANY KIND WHATSOEVER, EXPRESS OR IMPLIED, WITH RESPECT TO THE SOFTWARE. ALL IMPLIED WARRANTIES, INCLUDING, WITHOUT LIMITATION, THE IMPLIED WARRANTIES OF MERCHANTABILITY AND FITNESS FOR A PARTICULAR PURPOSE ARE HEREBY EXPRESSLY DISCLAIMED BY MDEA. IN NO EVENT SHALL MDEA BE LIABLE TO YOU OR ANY THIRD PARTIES, IN CONTRACT, IN TORT OR OTHERWISE, FOR ANY DIRECT, INDIRECT, SPECIAL, INCIDENTAL OR CONSEQUENTIAL DAMAGES OF ANY KIND OR NATURE. BECAUSE SOME JURISDICTIONS DO NOT ALLOW THE EXCLUSION OR LIMITATION OF IMPLIED WARRANTIES, THE ABOVE LIMITATION MAY NOT APPLY TO YOU.**

7. **LIMITATION OF LIABILITY. MDEA SHALL NOT, UNDER ANY CIRCUMSTANCES BE LIABLE TO YOU OR ANY THIRD PARTIES FOR ANY DAMAGES OF ANY NATURE, WHETHER INDIRECT, SPECIAL, INCIDENTAL, CONSEQUENTIAL OR OTHERWISE, INCLUDING, BUT NOT LIMITED TO, ANY CLAIMS FOR LOST PROFITS, LOSS OF GOOD WILL OR EXPENDITURES MADE OR COMMITTED FOR IN RELIANCE ON THE CONTINUATION OF THIS LICENSE. YOU AGREE THAT NEITHER MDEA’S BREACH OF THIS LICENSE NOR ITS FAILURE TO REPAIR A DEFECT, ERROR OR BUG SHALL CONSTITUTE A FAILURE OF THE ESSENTIAL PURPOSE OF THIS LICENSE. BECAUSE SOME JURISDICTIONS DO NOT ALLOW THE EXCLUSION OR LIMITATION OF LIABILITY FOR CONSEQUENTIAL OR INCIDENTAL DAMAGES, THE ABOVE LIMITATIONS MAY NOT APPLY TO YOU. MDEA’s liability to you for direct damages for any cause whatsoever and regardless of the form of the action, will be limited to the money paid by you for the TV (based on fair market value of the TV) that caused the damages.**

8. **GENERAL.** This License Agreement will be governed by the laws of the State of California.

WARNING: This product contains chemicals known to the State of California to cause cancer and/or birth defects or other reproductive harm.

Mitsubishi DLP™ Projection Television Limited Warranty

MITSUBISHI DIGITAL ELECTRONICS AMERICA, INC. (“MDEA”) warrants as follows to the original purchaser of this television from an authorized MITSUBISHI Audio/Video Dealer, should it prove defective by reason of against defects arising from improper workmanship and/or material:

a. Parts. The lenticular (i.e. front picture) screen is warranted against defects in materials and workmanship for a period of thirty (30) days from the date of the original purchase at retail. The lamp and all other parts (except any software incorporated into this television) are warranted for a period of one (1) year from the date of the original purchase at retail. We will repair or replace, at our option, any defective part without charge for the part. Parts used for replacement may be replaced with those of like kind and quality and may be new or remanufactured. Parts used for replacement are warranted for the remainder of the original warranty period.

b. Embedded Software. MDEA warrants that all software incorporated into this television set (the “Embedded Software”) will perform in accordance with the functional description of Embedded Software in all material respects, but MDEA does not warrant that the Embedded Software is error-free. MDEA also does not warrant that the Embedded Software will be compatible under IEEE 1394 AV/C and HAVi software standards with products produced by any other manufacturer. The limited warranty contained in this section shall continue for a period of one (1) year from the date of the original purchase at retail. If, after prompt notice within the warranty period, MDEA determines that the Embedded Software has failed to perform in accordance with such functional description in all material respects and if such failure is not due to accident, misuse, modification or misapplication of the Embedded Software, then MDEA shall modify or replace the nonconforming Embedded Software at no charge to you, which at MDEA’s sole discretion may be fulfilled by means of modification or replacement software contained on a replacement memory card for Customer installation. The foregoing shall be MDEA’s sole obligation to you under this limited warranty. All rights under this limited warranty on the Embedded Software also subject to your acceptance of and compliance with the terms of the Software License Agreement applicable to this television, and this limited warranty on the Embedded Software shall be null and void if the Embedded Software is modified or changed in any manner except as specifically authorized by MDEA.

c. Labor. For thirty (30) days after the original purchase at retail, we will repair or replace, at our option, the lenticular screen if it proves defective. For certain items that are designed to be replaced by the consumer, including (but not limited to) some Embedded Software, the consumer is solely responsible for any replacement labor. For all other parts, we will provide the labor for a warranty repair by an authorized MITSUBISHI service center without charge for one (1) year from the original date of purchase at retail.

d. Notice. To obtain warranty service, you must notify an authorized MITSUBISHI service center of any defect within the applicable warranty time period.

e. This DLP Projection Television uses a single DLP chip to create the screen image. This technology creates the image using small dots, or picture elements (pixels). Your DLP Projection TV is manufactured to a high level of performance and quality, in fact, 99.99% perfect in the number of properly functioning pixels. As in other display technology, sometimes a pixel is continuously active, inactive or the incorrect color. Our standard is clear; MDEA warrants only that the percentage of properly functioning pixels will be not less than 99.99% of all pixels.

BEFORE REQUESTING SERVICE, please review the instruction booklet to insure proper installation and correct customer control adjustment. If the problem persists please arrange for warranty service.

1. TO OBTAIN WARRANTY SERVICE:

a. Contact your nearest authorized MITSUBISHI service center, whose name and address can be obtained from your MITSUBISHI dealer, by writing at the address provided below, calling MDEA at the 800-332-2119, or by using the support feature of our website at www.Mitsubishi-tv.com.

b. Warranty service will be provided in your home or, if required, at an authorized service shop, provided that your television is located within the geographic territory customarily covered by an authorized MITSUBISHI service center. If not, you must either deliver your television to an authorized service location at your own expense, or pay for any travel and/or transportation costs the service center may charge to and from your home. Actual service labor will be provided without charge.

c. Proof of purchase date from an authorized MITSUBISHI dealer is required when requesting warranty service. Present your sales receipt or other document which establishes proof and date of purchase. THE RETURN OF THE OWNER REGISTRATION CARD IS NOT A CONDITION OF COVERAGE UNDER THIS LIMITED WARRANTY. However, please return the Owner Registration Card so that we can contact you should a question of safety arise which could affect you.

d. To obtain a replacement lamp during the warranty period, please contact the MDEA Consumer Relations Department at (800) 332-2119. After the warranty period you may order the lamp directly from the MDEA Parts Department at (800) 553-7278.

2. THIS LIMITED WARRANTY DOES NOT COVER:

a. Up to .01% pixel outages (small dot picture elements that are dark or incorrectly illuminated).

b. Damage to the lenticular screen or Fresnel lens, screen frame, cosmetic damage or to any other damage where such damage is caused by unauthorized modification, alteration, repairs to or service of the product by anyone other than an authorized MITSUBISHI service center; physical abuse to or misuse of the product (including any failure to carry out any maintenance as described in the Owner's Guide including air filter cleaning or any product damaged by excessive physical or electrical stress); any products that have had a serial number or any part thereof altered, defaced or removed; product use in any manner contrary to the Owner's Guide; freight damage; or any damage caused by acts of God or other factors beyond the reasonable control of MDEA, such as power surge damage caused by electrical system or lightning. This limited warranty also excludes service calls where no defect in the product covered under this warranty is found, service calls related to unsatisfactory audio or visual reception or signal unless caused by a defect in the product that is covered under this limited warranty, all costs, expenses or any other damages arising from product installation, or set-ups, any adjustments of user controls (including contrast, brightness, color, tint, fine tuning, sharpness), other adjustment necessary to prepare the unit for display or use, connection with any external audio receiver, antenna, cable or satellite systems, or service of products purchased or serviced outside the U.S.A. Please consult the operating instructions contained in the Owner's Guide furnished with the product for information regarding user controls.

3. ANY EXPRESS WARRANTY NOT PROVIDED HEREIN, AND ANY REMEDY WHICH, BUT FOR THIS PROVISION, MIGHT ARISE BY IMPLICATION OR OPERATION OF LAW, IS HEREBY EXCLUDED AND DISCLAIMED. THE IMPLIED WARRANTIES OF MERCHANTABILITY AND OF FITNESS FOR ANY PARTICULAR PURPOSE ARE EXPRESSLY LIMITED TO A TERM OF ONE YEAR.

4. UNDER NO CIRCUMSTANCES SHALL MDEA BE LIABLE TO PURCHASER OR ANY OTHER PERSON FOR ANY INCIDENTAL, SPECIAL OR CONSEQUENTIAL DAMAGES, WHETHER ARISING OUT OF BREACH OF WARRANTY, BREACH OF CONTRACT, OR OTHERWISE.

5. Some states do not allow limitations on how long an implied warranty lasts, or the exclusion or limitation of incidental, special, or consequential damages, so the above limitations or exclusions may not apply to you.

6. This limited warranty gives you specific legal rights, and you may also have other rights which vary from state to state.



MITSUBISHI DIGITAL ELECTRONICS AMERICA, INC.
9351 Jeronimo Road
Irvine, CA 92618-1904

Index

A

- A/V Memory Reset. *See* Reset
- A/V Receiver
 - Adding 45
 - Connecting 28
 - Inputs 45
 - Input Learn Screen 46
 - Learn Screen 46
- A/V Reset. *See* Reset
- A/V Settings Descriptions
 - Audio 80
 - Video 81
- Accessories, TV 10
- Add Device. *See* NetCommand
- Advanced Learn Screen, [Device] 50
- Antenna inputs (ANT-1 MAIN, ANT-2 AUX) 16
- Antenna with Leads, Connecting 25
- Audio/Video Menu 66, 79
- Audio Inputs 16

B

- Back Panel (illustrated) 16
- Batteries. *See* Remote Control

C

- CableCARD™ 11, 17, 23
 - CableCARD™ Menu 59
- Cable Box 53, 108
 - Connecting 24, 27
- Captions Menu 66, 74
- Change Device Screen. *See* NetCommand
- Channels 68, 72, 102. *See also* SQV and PIP viewing 86
 - Changing 72
 - Memorizing 67
 - Name 72
- ChannelView 60
- Channel Menu 72
- Cleaning and Service 111
- Clock
 - Set Date, Time 67
- Color Adjustments 81
- Component Inputs (YPbPr) 16
- Computer. *See* PC
- Connecting: Helpful Hints 35
- Connection for [Device] Screen 50
- Connection Screen 55
- Copy-Protected Material 62

D

- Date. *See* Clock
- Daylight Savings Time 68
- Demo Mode 20
- Device Menu 59
- Device Selection Menu 58
- Digital Audio Output 17
- Display Formats 87
- DTV Link 17
- DVD Player with Component Video, Connecting 29
- DVI Analog Audio 16
- DVI Device 29

F

- Film Mode 79
- Format Definitions 87
- Front Button Lock 77
- Front Control Panel 12

G

- GUIDE Key (button) 13, 14, 35, 60

H

- HDMI Device 30
- HDMI Input 17
- HDTV Receiver with Component Video, Connecting 30

I

- Icon Order 69
- IEEE 1394
 - Adding IEEE 1394 Devices Automatically 54
 - and NetCommand 53
 - Compatible IEEE 1394 Devices 33
 - Connecting IEEE 1394 Devices 33
 - IEEE 1394 Device Type Screen 55
 - Inputs 17
 - Name for 1394 Device Screen 54
 - New 1394 Device Screen 54
- Indicator Lights 95
 - Front Panel 12
 - Lamp Indicator 12
 - Power/Timer 13
 - Status 13

- Inputs (Audio/Video) 16

IR (Infrared)

- IR Code for [Device] Screen 51
- IR Emitter NetCommand® 16, 32

J

- JPEG Picture Thumbnails (Media Dialog Box) 84

L

- Lamp Cartridge Replacement 112
- Lamp Indicator. *See* Indicator Lights
- Lamp Reminder 68
- Language 67
- “Learn” Feature
 - A/V Receiver 45, 46
 - Code Reference Chart 105
 - Description 22, 38, 39
 - Device 50
 - Device Key Reference Chart 110
 - GUIDE Key 35
 - IEEE 1394 Devices 55
 - Troubleshooting 93, 94
- Learn Screen, [Device] 49
- Lock
 - Front Button Lock 77
 - Lock TV by Time 77
 - V-Chip Options 76

M

- Memorize Channels. *See* Channels
- Memory Cards 11
 - Media Setup Menu 85
 - Memory Card Reader 18, 19, 84
 - Playback 84
- Mute
 - Audio 74, 102
 - MUTE key 14
 - Video Mute 79

N

- Name Screen 47, 50
- NetCommand
 - Add Device 48
 - Change Device 52
 - Connecting External Devices 22
 - Delete Device 52
 - Description 11
 - Device Control (reference chart) 108

- Device Setup Screen 43
- Edit NetCommand Screen 48
- Initial Setup 42
- NetCommand Menu 69
- Pre-Memorized Devices 39
- Specialized Device Keys 110

O

- On-Screen Information 102

P

- Pass Code
 - Resetting 103
 - Setting 76
- PC 16, 17, 48, 54, 87
 - Connecting 31
 - Viewing 81, 89
- Peer-to-Peer Connection 63
- PerfectColor 81
- PIP (Picture in Picture) 86
 - PIP Device Selection Menu 58
- Playlist Menu, MP3 or WMA7 85

Q

- QV (QuickView™) 14

R

- Recording
 - Analog VCR and Viewing 114
 - Cancel Current Recordings 71
 - Default Digital (Record) Device 71
 - Digital VCR or A/V Disc and Viewing 115
 - Record List Screen 61, 71
 - REC Button 14, 60, 61, 70, 93, 97
 - Setup 61, 70
 - Time-Delayed 61, 70
 - VCR Recording from an Antenna or Cable Source 61
- Remote Control
 - and NetCommand® 39
 - Batteries 15
 - Functions 14
 - Programming 105
 - Programming Codes (reference chart) 105
 - Transport Buttons 69

Reset

- A/V (all settings) 13
- A/V Memory (for individual devices) 79
- DVCR Counter 109
- Lamp Reminder 68
- Pass Code 103
- PerfectColor 81
- Remote Control 15
- Reset Menu 20
- System Reset Button 12, 20, 92
- VCR Counter 108

- Review Screen 44

- RF Connection for Cable Screen 51

S

- S-Video 28
- Satellite Receiver 14, 22, 28, 30, 32, 39, 48, 53, 54, 60, 106, 107
- Search A/V Disc. *See* A/V Discs
- Setup Menu 66, 67
- Signal Definitions 87
- Speakers, TV 79
- Specifications, TV 100
- SQV (SuperQuickView™) 73
- Stand Requirements 2
- Status Indicator. *See* Indicator Lights
- Stereo. *See* A/V Receiver
- System Reset. *See* Reset

T

- Time. *See* Clock
- Timer 68
- Time Zone 68
- Track List Screen 64
- Transport Menu 69
- TV Guide On Screen 11, 14, 16, 24, 71, 72
 - Access Requirements 2
 - Setup 43

V

- V-Chip 78
 - Bypassing the V-Chip Lock 103
 - Ratings 78
 - V-Chip Lock Menu 66, 76
 - V-Chip Menu 76

- VCR 14, 16, 33, 54, 55, 58, 60, 94
 - and NetCommand Control 108, 109
 - Connecting 26, 27
 - NetCommand Default Input 22
 - NetCommand Pre-Memorized Models 39
 - NetCommand Specialized Device Keys 110
 - Programming Codes 106
 - Restrictions for Traditional VCRs 62
 - VCR for Recordings Screen 51
- Video Inputs 16
- Video Settings 81

W

- Wall Outlet Cable 24



Website:

www.mitsubishi-tv.com

E-mail:

MDEAservice@mdea.com

**To order replacement or
additional remote controls, lamp
cartridges, or Owner's Guides,
call**

800-553-7278

**For questions, call Consumer
Relations at**

800-332-2119